

PRO Glass

AUTO GLASS TOOLS & ACCESSORIES

EDITION 2022/2023

Cut-Out Technology



Preparation



Installation



Specialty Tools



Repair



Protection & Care



Cord & Wire Cut-Out Technology	5	1
Pull Knife Cut-Out Technology	35	2
Power Tools (electric & pneumatic)	47	3
Dismantling & Installation Tools	75	4
Scrapers & Miscellaneous Cutting Tools	97	5
Sensor Technology	113	6
Auto Glass Installation	129	7
Calibration & Diagnostics	159	8
Adhesive, Tapes & Rubber Profiles	175	9
Other Hand Tools	199	10
Toolkits & Storage Systems	215	11
Transportation & Storage of Glass	231	12
Windscreen Repair & Scratch Removal	243	13
Headlight Restoration	281	14
Vehicle Protection & Personal Protective Equipment	287	15
Cleaning, Maintaining & Coating	299	16

FOLLOW US ON OUR SOCIAL MEDIA CHANNELS

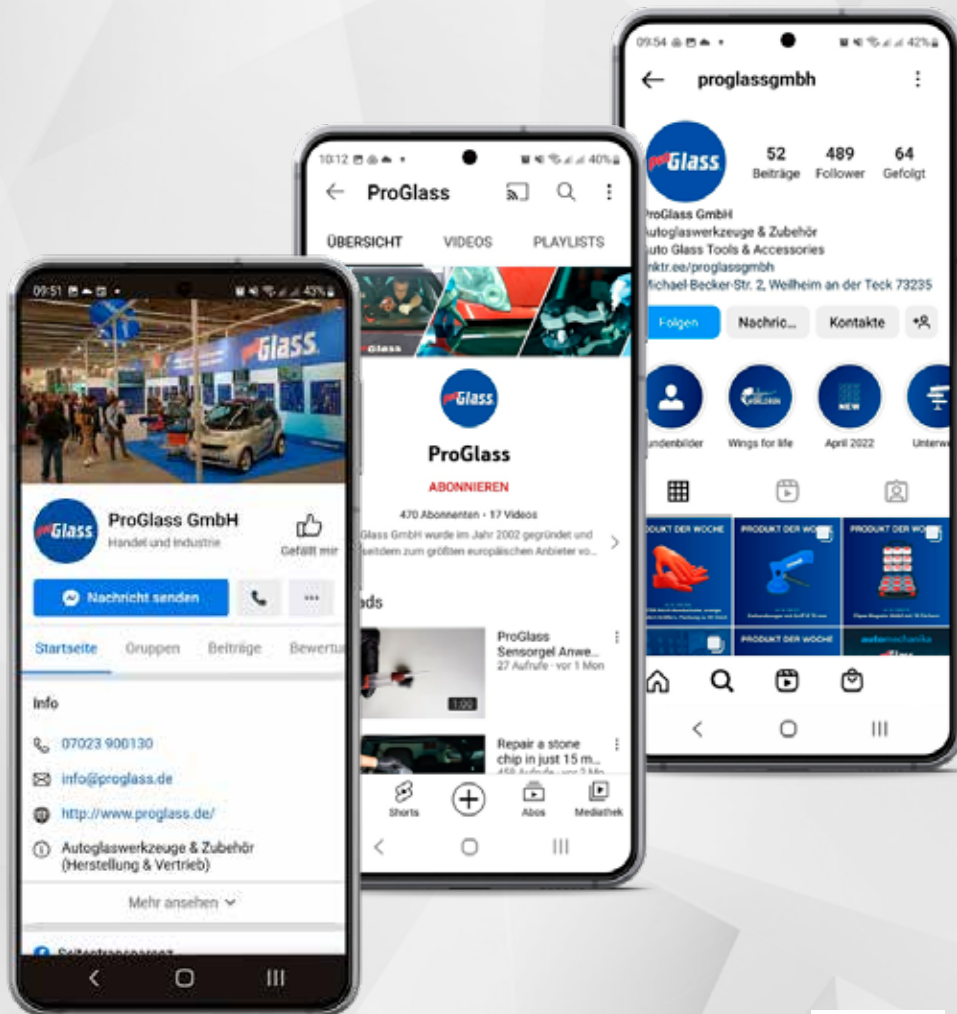

quicklink to
all channels



IMPRINT

Editor

ProGlass GmbH
Michael-Becker-Strasse 2
73235 Weilheim
Germany

Phone: +49 (0) 7023 / 90013-0
Fax: +49 (0) 7023 / 90013-23
E-Mail: info@proglass.de
Internet: www.proglass.de

VAT Reg. No.: DE 813 343 270

Managing Director: Oliver Siegler

Registered at local court
Stuttgart, HRB 231787

Copyright Note

This catalogue is copyrighted. Reproduction of any part in any way is prohibited without the exclusive written consent of ProGlass GmbH.

Trademarks

The name ProGlass and the ProGlass logo is a trademark by Oliver Siegler in favour of ProGlass GmbH.

Other product or company names in this catalogue are trademarks of the relative companies.

Date of Issue: August 2022
Errors and technical changes excepted!



When it was launched in 2012, the SPIDER from WRD Glass Tools revolutionised the glass removal market! The patented separating device was the first of its kind to enable the **completely damage-free separation of bonded vehicle windows**. A specially developed, extremely strong plastic separating cord is used to cut through the adhesive bead. This not only protects the bodywork and add-on parts, but also enables very fast work.



Due to the enormous increase in the tensile strength of the cord in recent years, the device itself has also had to become more and more stable. The current versions **SPIDER 3, SPIDER 4 and ORANGE BAT** therefore contain several detail improvements which either serve to increase the stability or to optimise the working method. Detailed information can be found in the product brochure and our website.

Schematic working method for a bonded windscreen removal in only four steps:

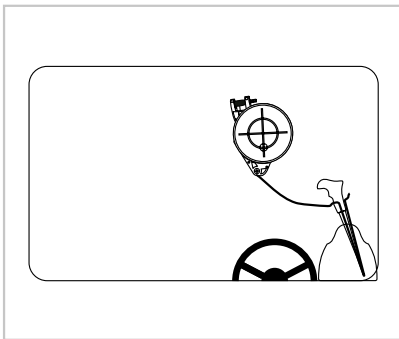

PREPARATIONS:

Pierce the line from inside to outside with the threading tool,...

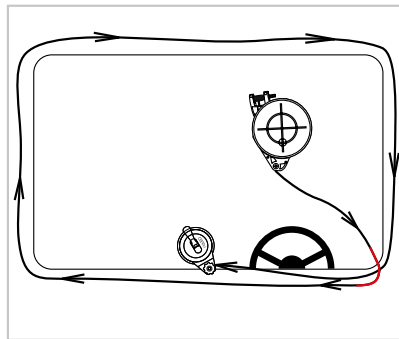

...guide it around the glasses edge and secure it with the anchor suction cup.

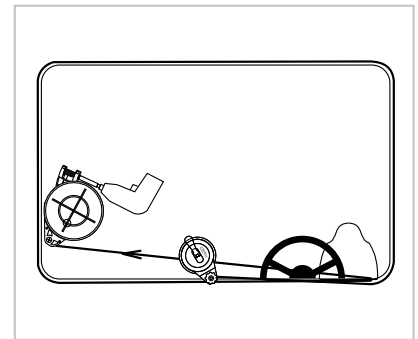

STEP 1:

Cut the adhesive bead from the starting point to the bottom right corner.

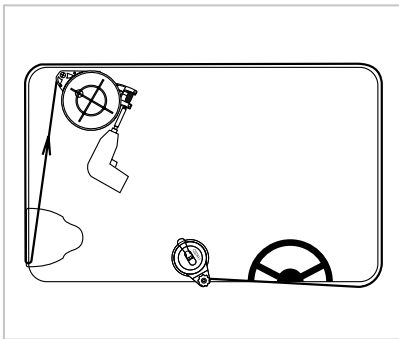

STEP 2:

Continue cutting the right A-pillar upwards until you reach the top right corner.

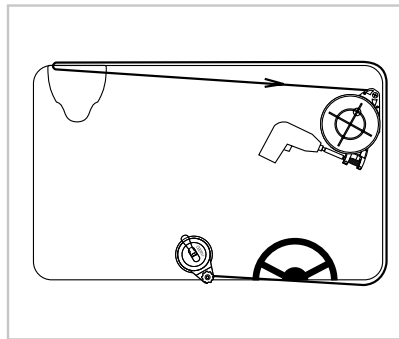

STEP 3:

Continue cutting across the roofside to the top left corner.

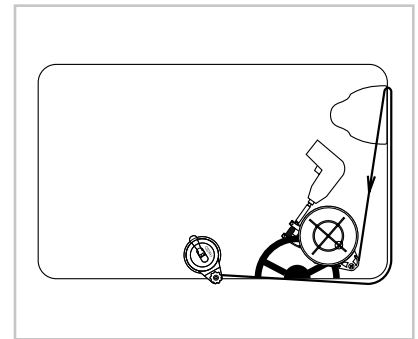

STEP 4:

Cut the left A-pillar downwards to the starting point.



■ WSP-003K

**Removal Device SPIDER 3
complete kit in plastic case**

Kit contains:

- 1 SPIDER cutting tool
- 1 cutting line threader (item no. DST-757-WSP)
- 1 dash protector (item no. DBP-1824-WSP)
- 1 bit long (item no. WSR-003K-BIT-L)
- 1 bit short (item no. WSR-003K-BIT-K)
- 4 holder pins (item no. WRD-LP)
- 1 cutting line install tool (item no. MS-180-WSP)
- 1 Spider cutting line, spool at 96 m (item no. P8)
- 1 anchor suction cup (item no. AS-115-K)
- 1 mini hook (item no. MH-140-WSP)
- 1 line & wire dispenser (item no. WRD-LD)
- 1 instruction manual
- 1 foam lined plastic case

Additionally needed accessories:

High-torque variable speed cordless drill, e.g.
Fein cordless drill 12 V (item no. ABSU-12C) or
Fein Cordless drill / driver 12 V (item no. ASCM-12C)



European Patent
No. EP 2 540 463
German Utility Patent
No. 20 2012 009 378.9

Further patents pending

*quicklink to the
product video*



■ WSP-004K



Removal Device SPIDER 4 complete kit in plastic case

Kit contains:

- 1 SPIDER cutting tool
- 1 cutting line threader (item no. DST-757-WSP)
- 1 dash protector (item no. DBP-1824-WSP)
- 1 bit long (item no. WSR-003K-BIT-L)
- 1 bit short (item no. WSR-003K-BIT-K)
- 4 holder pins (item no. WRD-LP)
- 1 cutting line install tool (item no. MS-180-WSP)
- 1 Spider cutting line, spool at 96 m (item no. P8)
- 1 anchor suction cup (item no. AS-115-K)
- 1 mini hook (item no. MH-140-WSP)
- 1 line & wire dispenser (item no. WRD-LD)
- 1 instruction manual
- 1 foam lined plastic case

Additionally needed accessories:

High-torque variable speed cordless drill, e.g.
Fein cordless drill 12 V (item no. ABSU-12C) or
Fein Cordless drill / driver 12 V (item no. ASCM-12C)

European Patent
No. EP 2 540 463
German Utility Patent
No. 20 2012 009 378.9

Further patents pending

*quicklink to the
product video*



■ WROBK-300K Fibre Line Removal Device Orange Bat Complete kit in plastic case



The Orange Bat from WRD Glass Tools is the ideal solution for quick and damage-free removal of all bonded vehicle windows - both mechanically and manually! The tool can be operated both manually with the hand crank supplied and mechanically with a cordless screwdriver.

The specially developed, extremely strong XN-96 plastic cutting cord is used to cut through the adhesive bead. This not only protects the bodywork and add-on parts, but also enables very fast work.

quicklink to the product video



■ XN-96

Spider cutting Line XN-96, 96 m

Special line made of high-tensile, braided polyethylene fibre. The line is designed for use with the Orange Bat & Spider cutting tool. The multiple reusable cutting line XN-96 offers a very high tensile strength and abrasion resistance at a diameter of 0.85 mm. In contrast to the P6 and P8 cutting lines, this line has no marked sections!

Application: with Orange Bat & SPIDER system
Tensile strength: 145 kg (1421 N)
Diameter: 0.85 mm





■ P6

**Spider Cutting Line P6, 96 m,
14 pre-marked lengths at 6.85 m on plastic spool**

Special line made of high-tensile, braided polyethylene fibre. The cord has pre-marked lengths which are matched for using it with the Spider cutting tool. The multiple reusable cutting line P6 offers a very high tensile strength and abrasion resistance at a diameter of only 0.6 mm. Thanks to the small diameter this line applies only gentle pressure on the glass so that most windscreens can be removed without breaking.

Application: with SPIDER removal system

Tensile strength: 110 kg (1078 N)

Diameter: 0.6 mm



■ P8

**Spider Cutting line P8, 96 m,
14 pre-marked lengths at 6.85 m on plastic spool**

Special line made of high-tensile, braided polyethylene fibre. The cord has pre-marked lengths which are matched for using it with the Spider cutting tool. The multiple reusable cutting line P8 offers a very high tensile strength and abrasion resistance at a diameter of 1.0 mm

Application: with SPIDER removal system

Tensile strength: 165 kg (1618 N)

Diameter: 1.0 mm



■ TS-135

ProGlass Cutting Line TS, Ø 0.5 mm, 135 m on plastic spool

Special line made of high-tensile, braided polyethylene fibre. Thanks to the very small diameter of only 0.5 mm this cutting line can be pulled manually (with handles TSG or DGL). But it can also be used with the SPIDER cutting tool, e. g. for cutting-out a glass that is installed very tight to the pinchweld. However, in that case the line could probably not be used more than once.

Application: manual pulling or with SPIDER removal system
Tensile strength: 95 kg (930 N)
Diameter: 0.5 mm

■ DBP-1824-WSP

Dashboard Protector for WRD Spider approx. 230 x 240 mm



Clear transparent Dashboard Protector from the SPIDER kit as a single/replacement part.

Dimensions: 230 x 240 mm

■ DBP-3316-WSP

Dashboard Protector for WRD Spider approx. 330 x 160 mm



Clear transparent Dashboard Protector for the SPIDER kit as an accessory part.

Dimensions: approx. 330 x 160 mm

■ DBP-4024-WSP

Dashboard Protector for WRD Spider approx. 400 x 240 mm



Clear transparent Dashboard Protector for the SPIDER kit as an accessory part.

Dimensions: approx. 400 x 240 mm



■ **AS-115-K**

Anchor Suction Cup Ø 115 mm (plastic) for WRD Spider

The vacuum cup with clamp screw is used for the secure fixation of the lose cord end when working with the SPIDER removal system.



■ **DST-757-WSP** **Cutting Line Threader**

Length: 340 mm

Cutting Line Threader from WRD Glass Tools with a flexible blade made of spring steel. Just lay the Spider cutting line over the notched tip and pass it through the polyurethane bead by pushing the tool from the inside to the outside.

Length: 340 mm



■ **MH-140-WSP** **Mini Hook 140 mm**

The mini hook with its double bent tip facilitates grabbing the cutting line from the pinchweld.



■ **MS-180-WSP** **Cutting line install tool**

A handy install tool for the SPIDER removal system with two different shaped ends. The notch on the one side allows you to lay the cutting line in difficult spots like e. g. at the bottom corners of many wind-screens. The eye on the other side is suitable for laying the cutting line fast and easy under sealing lips and encapsulations.



■ **WRD-LD**

Line & wire dispenser

Small and handy holder with suction cup. For easy fixing and unwinding of line and wire spools. The suction cup and small size make it easy to attach anywhere.



■ **W-1414**

Angle drive 1/4" for WRD Spider

Angle gear drive for using the Spider removal tool in constricted areas (e.g. for the removal of side glasses or backlites).

Dimensions (LxWxH): 170 x 60 x 25 mm

Gear Ratio: 1.285
Torque (max.): 60 N



■ **FBH-190**

Flexible bit holder for WRD Spider

The extended flexible bit holder enables you to cut-out small quarter glasses or strongly curved backlites with the WRD Spider. Due to the high torque force occurring in the cut-out process this component is not suitable for long-term work. For a continuous operation we recommend the angle drive W-1414.

Length: approx. 190 mm



■ **DSF-075**

Wire/Cord guiding needle Package of 10 pieces

Guide Pins are used from the outside in the PU bead, a must to guide the wire or line into the right position. Especially by windshield overhanging the pinchweld at bottom.

Total length: 75 mm



■ WRD-4RD

Quarter Glass Removal Kit



Designed for safe and efficient side glass panel extraction. Small form factor allows for use in wide range of small panels and applications. The WRD 4" Dock uses high tack 3M pads to temporary fasten a winding point to glass panels or directly to vehicle surfaces.

Kit contains:

- Removal Dock Base Ø 102 mm
- Removal Dock Spindle height 50 mm
- 3M Adhesive Pads (9 pcs)
- Molding Protectors (10 pcs)
- Hex Bit Long
- Hex Bit Short
- Tool Case
- Instruction Manual

■ WRD-DPS

Molding Protector package of 10



The Molding Protector-Card are used to cover Moldings by removal. For each glass demension and shape the card are used continuous fixed as needed under the Molding.

Dimensions (LxWxH): 154 x 56 x 0,35 mm



■ ABSU-12C



FEIN Cordless Drill / Driver incl. second battery pack (12.0 V Li-Ion / 3.0 Ah)

- Powerful and long-life DC motor with overheating and overload protection.
- Robust solid metal drill chuck with chucking force safety device.
- Short design of 180 mm.
- Perfect for use with stepped drill bit, e.g. for drilling initial holes in sheet metals.
- 17 torque levels – force can be easily metered up to 30 Nm for tough screw connections.
- 2-speed solid metal gearbox.
- Bright LED light on housing.
- 3.0 Ah battery capacity for up to 350 screw connections (5 x 40 mm).
- FEIN SafetyCell technology. Protects the battery and tool from overload, overheating and total discharge.
- The battery charge can be read off the battery.
- Includes belt holder and magnetic bit holder.
- One charger for all FEIN Li-ion batteries of all voltage classes.

■ BP-012-ABSU Li-Ion Battery Pack 12 V, 3.0 Ah for ABSU-12C / ASCM-12C

■ ASCM-12C



FEIN Cordless Drill / Driver incl. second battery pack (12.0 V Li-Ion / 3.0 Ah)

- Brushless FEIN PowerDrive motor, powerful and maintenance free for maximum efficiency and service life.
- Solid metal removable drill chuck for excellent load handling under the toughest conditions.
- The optimum cutting speed for any drill diameter thanks to 4-speed solid metal gearbox.
- Speed 4 for drilling 6 mm in metal at 2500 rpm.
- Speed 1 for powerful thread cutting.
- Optimum speeds for self-drilling screws.
- Speeds can be easily metered for work with stepped drill bit.
- Drill chuck with spindle lock and chucking force safety device.
- Compact 150 mm length (without drill chuck).
- 3.0 Ah battery capacity for up to 400 screw connections (5x 40mm).
- FEIN SafetyCell technology. Protects the battery and tool from overload, overheating and total discharge.
- The battery charge can be read off the battery.
- Includes belt holder and magnetic bit holder.
- Bright LED light on housing.
- One charger for all FEIN Li-ion batteries of all voltage classes.

**■ ASM-M12****Cordless Drill/Driver Milwaukee
incl. two battery packs (12.0 V Li-Ion / 2.0 Ah)**

- Milwaukee® high performance sub compact percussion drill measures 187 mm in length making it ideal for working within confined spaces
- REDLINK™ overload protection electronics in tool and battery pack deliver best in class system durability
- 10 mm metal chuck for quick bit changes and bit retention
- Optimised handle for better control and improved grip
- Individual battery cell monitoring optimises tool run time and ensures long term pack durability
- On board fuel gauge and LED light - added user convenience and illumination in low lit working conditions
- REDLITHIUM-ION™ battery pack provides superior pack construction, electronics and fade-free performance to deliver more run time and more work over pack life
- Flexible battery system: works with all Milwaukee® M12™ batteries
- Included: Suitcase, Charger, 2 Battery, Belt clip

■ **TSG-400**

Cutting Line Handles, set of 2 pieces

Pull handle from WRD Glass Tools in the design of the Spider removal tool. With the ergonomically shaped pull handles the fibre line is clamped reliably and hence can be used also for manual cutting of adhesive beads as well as for the removal of spoilers, trims, badges, antenna covers, etc. With useful PVC suction cup for safe „parking“ of the handle on all smooth surfaces.



■ **TSG-401**

Cutting Line Handle, single

Pull handle from WRD Glass Tools in the design of the Spider removal tool. With the ergonomically shaped pull handle the fibre line is clamped reliably and hence can be used also for manual cutting of adhesive beads as well as for the removal of spoilers, trims, badges, antenna covers, etc. With useful PVC suction cup for safe „parking“ of the handle on all smooth surfaces.



■ **ESS-150**

ProGlass One Man Cutting Line Tool Kit ESS

Tool kit for the manual cut-out of bonded vehicle glazing and attached parts with cutting line by only one person.

Thanks to the small diameter the ProGlass cutting line TS can also be operated manually. For cutting out windscreens (or other bonded glasses and attached parts) by only one person this kit contains a 150 mm diameter suction tool with a recessed arm and a fixing point for the cutting line. Attached to the inside of a windscreen this suction tool will hold the line end securely while you cut through the adhesive by pulling with the pull handle from outside.

Kit contains:

- 1 suction cup with cutting line fixing point (item no. ESS-150)
- 1 ProGlass cutting line, 135 m (item no. TS-135)
- 1 wire threader (item no. DST-210)
- 1 cutting line handle with suction cup (item no. DGL-201TS)



■ **DGL-201TS**

Cutting Line Handle with suction cup

The fixed suction cup allows you to stick this handle to the glass or even the painted car body. So you can go around the vehicle's front and grab it from the other side easily. The handle will not fall down and hit the car body.

The handle is made of shock resistant plastic, sleeve and shaft are made of chrome-plated metal. Suction cup made of clear PVC.



■ VIP-1138

Cut-Out System Equalizer Viper tool kit in soft carry case

The Equalizer® Viper™ is a wire removal device designed for small quarter glass removals, but can also be used on windshields and back glasses. It's small, light, and easy to maneuver. Simply use a 1/2" drive ratchet with a 1-1/8" socket slipped over the shaft of the tool to rotate the wire reel. The double direction capability of the reel allows for optimum use and the magnetic points on the ratchet shaft ensure that your ratchet stays firmly attached to the tool, even in steep/vertical scenarios.



Kit Includes:

- 1 Viper Tool (Includes 1/2" Drive Ratchet & 1-1/8" Socket)
- 1 Center Start
- 1 Mini Anchor
- 1 Clear Dash Protector
- 1 Roll of Squire™ Wire
- 1 Spool of RipCord
- All packaged in a soft carry case with foam liner.
- Wire/Cord Guiding Needles
- Pointed Pliers

*quicklink to the
product video*



■ RAP-F22

Equalizer Raptor removal tool

The Equalizer® Raptor™ is a wire removal device designed for small quarter glass removals, but can also be used on windshields and back glasses.

It's small, light, and easy to maneuver. Simply operate the tool manually with the ratchet included with the kit. Include a Constant Vacuum Cup per a electric pumping system which hold the tool on the glass. The double direction capability of the reel allows for optimum use and the magnetic points on the ratchet shaft ensure that your ratchet stays firmly attached to the tool, even in steep/vertical scenarios.



ProGlass Sawing and Cutting Wires

It was in the seventies when the first passenger cars in Europe were manufactured with a bonded windscreen and the garages were faced with a problem: How could they remove the windscreen from the vehicle without smashing the glass with a hammer?

The first solution was found by using piano wire. On the one hand these wires were thin and on the other hand solid enough. Two pieces of wood had to suffice as handles to hold the wire ends – by that the bonding could be cut through and the glass be taken out in one piece. From this, over the years, a braided wire – similar to our todays Sawing Wire SD – was developed. That is why this type of wire is still known as “piano wire”.

Another frequently used thing in these days was “cheese wire”, thus a wire made for cutting cheese. Although this term is also still used by many technicians the current cut-out wires for bonded auto glass have not a lot in common with the products used in former times.

But this very day sawing and cutting wires still are the most commonly used tool for cutting out bonded auto glass. In our range we carry four different types of metal wires with different cross-sections and sizes. Depending on the application and personal liking every auto glass technician will find his favourite wire on the following pages.





■ SD-02

**ProGlass Sawing Wire SD,
Ø 0.80 mm, ring at 2.0 m**

■ SD-22

**ProGlass Sawing Wire SD,
Ø 0.80 mm, 22 m on plastic spool**

■ SD-44

**ProGlass Sawing Wire SD,
Ø 0.80 mm, 44 m on plastic spool**

ProGlass sawing wire is made of three resistant, brass-plated steel wires that are braided to one strand. The result is a very stable and still flexible sawing wire with a diameter of 0.80 mm. Because of its sawing action this wire is especially good for extra wide or tough bondings.

The wire is held on the plastic spool by a wide rubber band that makes it easy to spool off and cut a required portion while the remaining wire is safely held on the spool.

Application: to saw only

Tensile strength: 110 kg (1078 N)

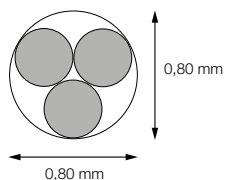



■ **DD-02**

■ **DD-50**

**ProGlass Cut-Out Wire DD,
triangular 0.8 x 0.8 mm, ring at 2.0 m**

**ProGlass Cut-Out Wire DD,
triangular 0.8 x 0.8 mm, 50 m in cardboard box**

Due to the pointed cutting angle of 60° the ProGlass triangular cut-out wire has a particularly good cutting ability. To avoid damages to the painted car body and to the interior this cutting wire should be used mainly for cutting easily accessible bondings.

Application: to pull only

Tensile strength: 75 kg (736 N)

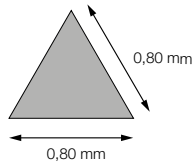



■ VKD-02

**ProGlass Cut-Out Wire VKD,
squared 0.6 x 0.6 mm, ring at 2.0 m**

■ VKD-22

**ProGlass Cut-Out Wire VKD,
squared 0.6 x 0.6 mm, 22 m on plastic spool**

■ VKD-44

**ProGlass Cut-Out Wire VKD,
squared 0.6 x 0.6 mm, 44 m on plastic spool**

Because of its sharp edges this wire has the best cutting action when it is pulled - it is not made for sawing as it would break too fast! To avoid damages to the painted car body and to the interior squared cutting wire should be used mainly for cutting easily accesible bondings.

The wire is held on the plastic spool by a wide rubber band that makes it easy to spool off and cut a required portion while the remaining wire is safely held on the spool.

Application: to pull only
Tensile strength: 70 kg (686 N)

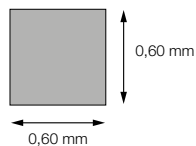



■ XKD-02

ProGlass Cutting Wire XKD, squared 0.7 x 0.7 mm, ring at 2.0 m

■ XKD-22

ProGlass Cutting Wire XKD, squared 0.7 x 0.7 mm, 22 m on plastic spool

■ XKD-44

ProGlass Cutting Wire XKD, squared 0.7 x 0.7 mm, 44 m on plastic spool

The tensile strength of ProGlass XKD cutting wire is by 36% higher than of VKD cutting wire. Therefore this square wire is especially good for cutting double beads or extremely wide polyurethane beads. Thanks to its high tensile strength and the excellent cutting ability this wire works also great with cutting systems like the Roll-Out, CUT-IT, Viper or the Glass Bot.

The wire is held on the plastic spool by a wide rubber band that makes it easy to spool off and cut a required portion while the remaining wire is safely held on the spool.

Application: to pull only
Tensile strength: 95 kg (931 N)

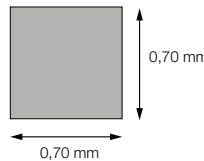



■ **ADR-300**

FEIN Cutting Wire 300 m

Replacement wire for FEIN SuperWire cutting system



■ **DSS-704**

**ProGlass Wire Cutting Kit DSS
with squared and braided wire, in 5 parts**

Kit contains:

- 1 T-handle wire threader (item no. DST-733)
- 1 pair of wire handles (item no. DGL-200)
- 1 ProGlass sawing wire, 22 m (item no. SD-22)
- 1 ProGlass cutting wire, 22 m (item no. VKD-22)



■ **SDK-202**

**ProGlass Wire Cutting Kit SDK
with braided wire, in 4 parts**

Kit contains:

- 1 wire threader (item no. DST-125)
- 1 pair of wire handles (item no. DGL-200)
- 1 ProGlass sawing wire, 22 m (item no. SD-22)



■ **VKS-202**

**ProGlass Wire Cut-Out Kit VKS
with squared wire, in 4 parts**

Kit contains:

- 1 wire threader (item no. DST-125)
- 1 pair of wire handles (item no. DGL-200)
- 1 ProGlass cutting wire, 22 m (item no. VKD-22)

■ EDS-150



ProGlass One Man Wire Cut-Out Tool Kit EDS

The 150 mm diameter sucker holds the wire absolutely reliable in place and takes over the part of the second person!

Very easy and fast attachment of the bell-shaped sucker by merely pressing it against the glass. The wire is driven very close to the glass to avoid damages to the dash board or interior linings.

Adapted for squared and triangular wire (not for sawing wire!)

Kit contains:

- 1 suction cup with wire fastener (item no. EDS-150-S)
- 1 primer/cleaner for suction cups (item no. HRS-100)
- 1 ProGlass Cut-Out Wire DD, triangular 50 m (item no. DD-50)
- 1 ProGlass squared cutting wire, 22 m (item no. VKD-22)
- 1 wire threader (item no. DST-210)
- 1 wire handle with suction cup (item no. DGL-201S)

quicklink to the product video



■ EDS-150-0



ProGlass One Man Wire Cut-Out Tool EDS

Kit contains:

- 1 suction cup with wire fastener (item no. EDS-150-S)
- 1 primer/cleaner for suction cups (item no. HRS-100)

■ VSR-73E



One Man Wire Cut-Out Tool Kit

The 120 mm diameter sucker with rotating device and retaining spring pulls the wire back after each cut and so replaces the second person! Secure and fast attachment of the suction cup with the integrated vacuum pump. The wire is driven close to the glass to avoid damages to the dash board or interior linings. Adapted for sawing wire, only conditionally for round or squared cutting wire.

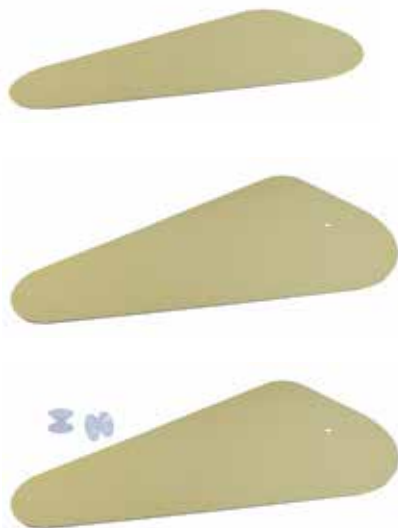

- **DBP-4525**
- **DBP-6030**
- **DBP-6030-S**

ProGlass Dashboard Protector approx. 49 x 26 cm

ProGlass Dashboard Protector approx. 60 x 30 cm

ProGlass Dashboard Protector with 2 suction cups approx. 60 x 30 cm

The Dashboard Protector is made of a 2 mm plastic material. The elastic plastic material adapts to all curves and is at the same time very imperishable and strong so that all cutting and sawing wires slide along easily.

This tool is the perfect companion to cut out glasses using wire. Thanks to the special shape it can be used practically on all sides and corners of all cars. Push the board between dashboard/interior trim and glass until it touches the adhesive bead. By that you will not only avoid any kind of damages to the sensible surfaces of interior parts but also protect the VIN plate and the pinchweld edges.



- **DBP-3725**



Dashboard Protector approx. 37 x 25 cm

The Dashboard Protector is made of a 2 mm plastic material. The elastic plastic material adapts to curves and is at the same time very imperishable and strong so that all cutting/sawing wires and line slide along easily. This tool is the perfect companion to cut out glasses using wire and line. Push the board between dashboard/interior trim and glass until it touches the adhesive bead. By that you will not only avoid any kind of damages to the sensible surfaces of interior parts but also protect the VIN plate and the pinchweld edges.

- **DBP-4530-SET** **ProGlass Dashboard Protector Set in 4 parts**



The Dashboard Protector Set consists of 2 small and 2 big boards made of 2.5 mm thick plastic material. One small and one big board are curved to fit all curved parts inside the vehicle. This tool is the perfect companion to cut out glasses using wire and line. Push the board between dashboard/interior trim and glass until it touches the adhesive bead. By that you will not only avoid any kind of damages to the sensible surfaces of interior parts but also protect the VIN plate and the pinchweld edges. Approx. 27 x 20 cm + 45 x 30 cm.

■ DH-280

ProGlass Wire Hold
approx. 300 mm long, powder-coated steel

Simple tool to protect the interior trims when cutting out a bonded vehicle glass with wire.

The wire hold is fixed with its two suction cups from the inside of the glass, close to the glasses edge. The cutting or sawing wire is thereby guided closely to the glass and can not cut into A-pillar trims or the roof lining.



■ DP001P00

ICOR Dashboard Protector,
set of 2 pieces, approx. 62,5 x 24 cm

ICOR Dashboard Protector,
 set of 2 pieces, approx. 62,5 x 24 cm



■ DP001P01

ICOR Protective Board for A-pillars
and roofliners, approx. 40 x 10 cm

ICOR Protective Board for A-pillars
 and roofliners, approx. 40 x 10 cm





■ DFS-100

Wire Guiding Spatula with wooden handle, 100 mm wide blade

The spatula is very practical to guide the wire from inside the vehicle. This tool is especially helpful to lift the wire over positioning pins or to loosen these pins from the glass.



■ ULR-120

ProGlass Guide Roller With Pump Cuction Cup

- for guiding the cutting wire from inside of the vehicle
- leading the wire in an optimized angle facilitates cutting
- secure mounting to the glass with integrated vacuum pump
- suitable for manual use as well as for wire cutting tools
- suction cup Ø 120 mm

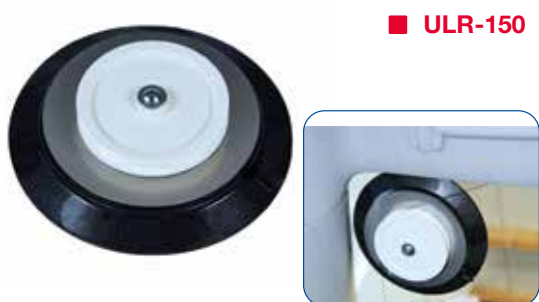

■ ULR-150

ProGlass Guide Roller With Suction Cup

- for guiding the cutting wire from inside of the vehicle
- leading the wire in an optimized angle facilitates cutting
- easy mounting by merely pressing the bell-shaped suction cup against the glass
- suitable for manual use as well as for wire cutting tools
- suction cup Ø 150 mm



■ MAC-1125

Mini Anchor Cup

The mini anchor with loop allow a secure fixing from all wire or cordless ends by working with diverse cutting systems. Trough his little diameter from only Ø 55,0 mm perfect to be used by small quarter glass removals.

■ **DGH-300**

ProGlass Wire Guide



The wire guide can prevent you from damaging the dash board, interior trims or the painted body of the vehicle. Length of the flat tip: 7 cm, overall length of the tool is approx. 34 cm. Knurled head screw with thread in M4 for secure fastening of the wire without the use of tools.

■ **DGS-301**

ProGlass Wire Guide and Wire Handle

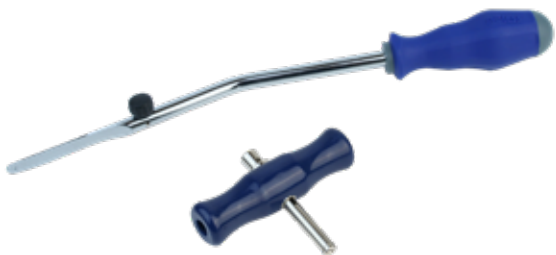

Kit contains:

- 1 wire guide (item no. DGH-300)
- 1 wire handle (item no. DGL-201)

■ **DHL-300**

ProGlass Wire Guide, long version



The extra long wire guide also works with the latest Mini-Vans and Coupés because his flat tip is real 16 cm long! Overall length of the tool is ca. 38 cm. Knurled head screw with thread in M4 for secure fastening of the wire without the use of tools.

■ **SPZ-160**

Pointed Pliers With Wire Cutter
170 mm long



Pointed pliers make it easy to grip the wire end after it has been pierced through the adhesive bead. These pointed pliers do also have an integrated wire cutter.



■ **DGL-200**

Wire Handles, set of 2 pieces

These self-locking wire handles have an excellent grip on each type of wire.

The handle is made of shock resistant plastic, sleeve and shaft are made of chrome-plated metal.



■ **DGL-201**

Wire Handle, single

This self-locking wire handle has an excellent grip on each type of wire.

The handle is made of shock resistant plastic, sleeve and shaft are made of chrome-plated metal.



■ **DGL-201S**

Wire Handle With Suction Cup

The fixed suction cup allows you to stick this handle to the glass or even the painted car body. So you can go around the vehicle's front and grab it from the other side easily. The handle will not fall down and hit the car body. The wire will not unnecessarily touch the painted car body or other damageable surfaces.



■ **TWH-500**

Wire Handles TightWire, set of 2 pieces

Wire handles with screw-clamp fastening. For quick and secure fixing of all sawing and cutting wires as well as cutting lines.

Unscrew the handle, insert the wire end into the hole and bend it over, pull it around the bolt at least one time and twist the handle back together tightly.

Made of aluminium with red vinyl cover.

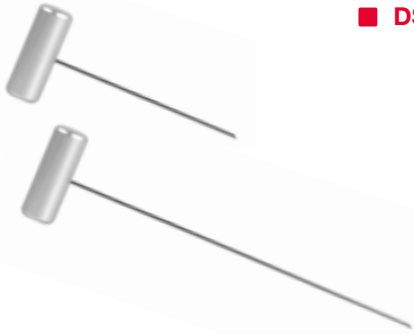

- DST-125
- DST-210

T-Handle Wire Threader, small length: 125 mm

T-Handle Wire Threader, small length: 210 mm

Hollow needle made of steel with a T-handle made of aluminium to pierce the polyurethane bead and pass the wire through.

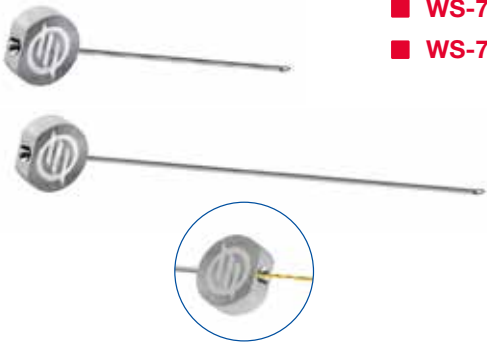

- WS-782
- WS-782P

O-Handle Wire Threader, small, Length: 125 mm

O-Handle Wire Threader, long, Length: 230 mm

Hollow needle made of steel with aluminium handle to pierce the polyurethane bead and pass the wire through.

■ **DST-733****T-Handle Wire Threader, large**
Length: 325 mm

Very solid wire threading device with a flexible blade made of spring steel. Just lay the wire in the notched tip and pass it through the polyurethane by pushing the tool from the inside to the outside.

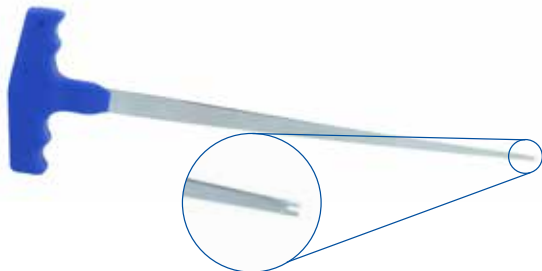
■ **DST-410****T-handle Wire Threader, extra long,**
Length: 410 mm

Very solid wire starter with T-handle and extra long spring steel blade. The wire is placed over the notched tip and through from the inside the adhesive bead is stung, or after piercing from the outside through the eye (Ø 1.6 mm) and with the tool inside drawn.

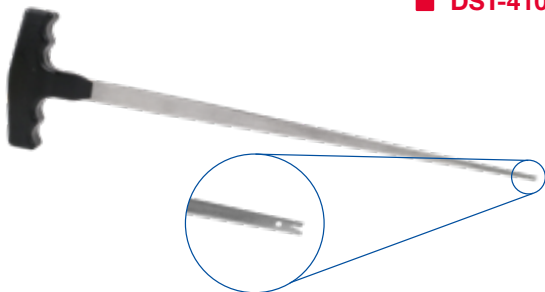
■ **DST-745****L-handle Wire Threader, large**
Length: 340 mm

Very solid wire threading device with a flexible blade made of spring steel. Just lay the wire in the notched tip and pass it through the polyurethane by pushing the tool from the inside to the outside.

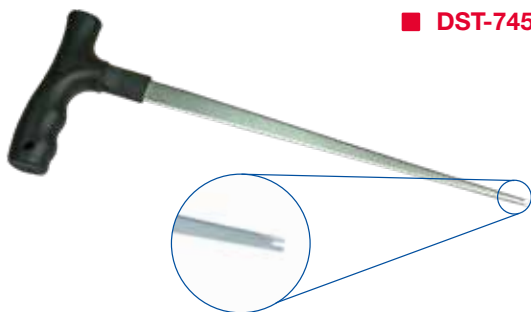
■ **DST-757****L-Handle Wire Threader, large**
Length: 340 mm

Very solid wire threading device with a flexible blade made of spring steel. Push the tip through the polyurethane from the inside to the outside, pass the wire through the eye (Ø 1.6 mm) and pull the tool back.

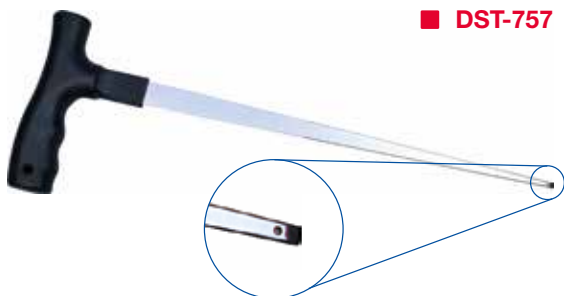





■ **SMQ-525**

ProGlass Pull Knife Kit in plastic case

Kit contains:

- 1 ProGlass pull knife (item no. ZMQ-500)
- 1 stainless steel blade 25 mm (item no. UW-725)
- 1 stainless steel blade 38 mm (item no. UW-738)
- 1 scraper blade 19 mm (item no. SK-119)
- 1 foam lined plastic case 240 x 215 x 45 mm



■ **ZMQ-500**

ProGlass Pull Knife with quick release system, with neoprene handle cover

- ergonomically shaped pull knife for optimum power transmission
- non-skid and protecting covers to avoid scratches
- blade exchange within seconds
- includes 1 stainless steel blade 25 mm long



■ **ZMX-400**

ProGlass Pull Knife with quick release system

- ergonomically shaped pull knife for optimum power transmission
- corrugated handle design with maximum grip
- blade exchange within seconds
- includes 1 stainless steel blade 25 mm long



■ **ZGL-195**

ProGlass Pull Handle with neoprene cover

Replacement pull handle, suitable for the ProGlass pull knives ZMK-110, ZML-395, ZMQ-500 and ZMX-400.



■ **ZFK-3007**

ProGlass Pull Knife / Pinchweld Scraper Kit

Complete tool kit for cutting-out bonded vehicle glasses and for preparing the pinchweld for the replacement glazing.

Kit contains:

- UltraWiz Pull Knife with fast release system
- UltraWiz Serrated Blade, 19 mm long
- UltraWiz Serrated Blade, 25 mm long
- UltraWiz Serrated Blade, 38 mm long
- Scraper, 120 mm long
- 10 Scraper Blades, 18 mm wide
- Parer Blade, Ø 6 mm
- Parer Blade, Ø 12 mm
- foam lined plastic case



■ **UW-3007**

UltraWiz Pull Knife with fast release lever mechanism, with flexible pull handle

UltraWiz Lever Pull Knife with ergonomic handle design and unique fast release lever mechanism. Opening the lever releases the blade immediately. The blade can be adjusted stepless within a wide range. By closing the lever the blade is held in position securely. Includes 1 pull knife blade 25 mm long.



■ **UW-3001**

UltraWiz Pull Knife with flexible pull handle

UltraWiz pull knife with ergonomic handle design. The lateral locking screw makes blade replacements faster than with standard pull knives. Includes 1 pull knife blade 25 mm long.



■ **UW-3001RK**

UltraWiz Pull Handle

Replacement pull handle for the UltraWiz pull knives UW-3001 und UW-3007.



■ **ZKS-110**

ProGlass Standard Pull Knife, short model

Rugged and proved standard pull knife with flexible pull handle. The short handle facilitates working in constricted area (e.g. below the bonnet). Includes 1 pull knife blade 25 mm long.

total length: 105 mm (incl. blade /excl. handle)



■ **ZMK-110**

ProGlass Pull Knife with neoprene cover, short model

Rugged and proved standard pull knife with flexible pull handle. The short handle facilitates working in constricted area (e.g. below the bonnet). With neoprene covered handles and PVC covered pull cable for better handling and to avoid scratches. Includes 1 pull knife blade 25 mm long.

total length: 110 mm (incl. blade /excl. handle)



■ **ZML-395**

ProGlass Pull Knife with neoprene cover

Rugged and proved standard pull knife with flexible pull handle. With neoprene covered handles and PVC covered pull cable for better handling and to avoid scratches. Includes 1 pull knife blade 25 mm long.

total length: 170 mm (incl. blade /excl. handle)



■ **ZMS-382**

ProGlass Standard Pull Knife

Rugged and proved standard pull knife with flexible pull handle. Includes 1 pull knife blade 25 mm long.

total length: 165 mm (incl. blade /excl. handle)



■ WRD-RK



Rhino Knife Cold Knife with 1 x serrated 25 mm blade

Very stable and handy cold knife with magnetized blade insertion for quick and easy change. Through his special design you can pull and push the knife by using relatively easily. Includes 1 serrated blade 25 mm long.



■ UW-3055-K

UltraWiz UltraReach Cold Knife

Bow type knife with non-slip handle for a good grip and controlled cutting. Greater reach thanks to the length-adjustable handle. The bow handle can be swiveled 45 ° left and right and can therefore be used flexibly. Easy blade change by pushing the blade in and out. Suitable for pulling and pushing, can be used on the left & right. Suitable for all standard cold knife blades.

Supplied with 1 blade 25 mm.



■ ZK-35

■ ZK-45



ZipKnife Cold Knife, 220 x 150 mm

ZipKnife Cold Knife, Compact, 225 x 80 mm

ZipKnife Cold Knife has a ergonomic bow type handle for a optimum hold and controlled cut. Easy blade exchange per pull and push the blade. The Cold Knife is usable on both ways left and right per pull and push. Uses all standard cold knife blades. Advantages of the compact version: Facilitates working in narrow spaces, e.g. under the hood.

Note: shipped without blade!





■ **UW-109**

UltraWiz Pull Knife Blade 9 mm long package at 5 pieces

■ **UW-1000-P**

UltraWiz Pull Knife Blade 9 mm long package at 10 pieces



■ **UW-119**

UltraWiz Standard Pull Knife Blade 19 mm long package at 5 pieces

■ **UW-1001-P**

UltraWiz Standard Pull Knife Blade 19 mm long package at 10 pieces



■ **UW-125**

UltraWiz Standard Pull Knife Blade 25 mm long package at 5 pieces

■ **UW-1002-P**

UltraWiz Standard Pull Knife Blade 25 mm long package at 10 pieces



■ **UW-138**

UltraWiz Standard Pull Knife Blade 38 mm long package at 5 pieces

■ **UW-1004-P**

UltraWiz Standard Pull Knife Blade 38 mm long package at 10 pieces

The Standard series from UltraWiz marks the worldwide industry standard for pull knife blades. Made of carbon steel (a low-alloy steel with a high carbon content) these blades offer a fine edge in combination with a good durability and hardness.

Suitable for all pull knives in our range.

■ **UW-6991**

UltraWiz Serrated Blade, 19 mm long, package at 5 pieces

■ **UW-6992**

UltraWiz Serrated Blade, 25 mm, long package at 5 pieces

■ **UW-6994**

UltraWiz Serrated Blade, 38 mm long, package at 5 pieces

The advantages of a serrated blade are already known from various powered cutting tools. With these new serrated pull knife blades UltraWiz has proven that serrations also offer benefits on of hand-operated blade.

The sharp teeth pierce the polyurethane when pulling the blade. In connection with the thin cutting edge this clearly facilitates the cutting process. At the same time the blade can be re-sharpened on the outside without losing its serrations. Thus this blade has a very long service life.

Suitable for all pull knives in our range.

■ **UW-519**

UltraWiz Pull Knife Blade, extra thin, 19 mm long package at 5 pieces

■ **UW-5001-P**

UltraWiz Pull Knife Blade, extra thin, 19 mm long package at 10 pieces

■ **UW-525**

UltraWiz Pull Knife Blade, extra thin, 25 mm long package at 5 pieces

■ **UW-5002-P**

UltraWiz Pull Knife Blade, extra thin, 25 mm long package at 10 pieces

■ **UW-538**

UltraWiz Pull Knife Blade, extra thin, 38 mm long package at 5 pieces

■ **UW-5004-P**

UltraWiz Pull Knife Blade, extra thin, 38 mm long package at 10 pieces

The UltraThin series from UltraWiz has a 40% thinner cutting edge than the standard blades. Therefore these blades cut more easily through adhesive beads but still offer the same durability and hardness than the UltraWiz Standard blades.

Suitable for all pull knives in our range.



- **UW-51C1** UltraWiz Paint Protection Blades 19 mm long package at 5 pieces
- **UW-51C1-P** UltraWiz Paint Protection Blades 19 mm long package at 10 pieces
- **UW-51C2** UltraWiz Paint Protection Blades 25 mm long package at 5 pieces
- **UW-51C2-P** UltraWiz Paint Protection Blades 25 mm long package at 10 pieces
- **UW-51C4** UltraWiz Paint Protection Blades 38 mm long package at 5 pieces
- **UW-51C4-P** UltraWiz Paint Protection Blades 38 mm long package at 10 pieces

This blade series has a smooth plastic coating on the back, so if the blade touches the paint, it will not be damaged. The coating is very tough and will not easily rub off. The blade is based on the UltraWiz UltraThin series, so it is one of the thinnest blades in the industry.

Suitable for all pull knives in our range.



- **UW-719** UltraWiz Stainless Steel Blade, 19 mm long
- **UW-7001-P** UltraWiz Stainless Steel Blade, 19 mm long package at 10 pieces
- **UW-725** UltraWiz Stainless Steel Blade, 25 mm long
- **UW-7002-P** UltraWiz Stainless Steel Blade, 25 mm long package at 10 pieces
- **UW-738** UltraWiz Stainless Steel Blade, 38 mm long
- **UW-7004-P** UltraWiz Stainless Steel Blade, 38 mm long package at 10 pieces

With the Stainless Steel series in the year 2000 UltraWiz presented the first coined stainless steel blade of the auto glass industry. The blade combines the known advantages of the Standard series with an improved durability, a better consistency and a longer lasting sharp edge. As each of these blades can be used for a very long time we offer them not only in the original package at 10 pieces but also as single packaged blades.

Suitable for all pull knives in our range.

■ UWS-6

**UltraWiz Blade Assortment, in 6 parts**

Kit contains:

- 1 UltraWiz Pull Knife Blade 19 mm
- 1 UltraWiz Pull Knife Blade 25 mm
- 1 UltraWiz Pull Knife Blade 38 mm
- 1 UltraWiz Pull Knife Blade, extra thin, 19 mm
- 1 UltraWiz Pull Knife Blade, extra thin, 25 mm
- 1 UltraWiz Pull Knife Blade, extra thin, 38 mm

■ UWG-3

**UltraWiz Serrated Blade Assortment, in 3 parts**

Kit contains:

- 1 UltraWiz Serrated Blade 19 mm long
- 1 UltraWiz Serrated Blade 25 mm long
- 1 UltraWiz Serrated Blade 38 mm long

■ UWE-3

**UltraWiz Stainless Steel Blade Assortment, in 3 parts**

Kit contains:

- 1 UltraWiz stainless steel blade 19 mm
- 1 UltraWiz stainless steel blade 25 mm
- 1 UltraWiz stainless steel blade 38 mm

Suitable for all pull knives in our range.

■ **UW-1012**

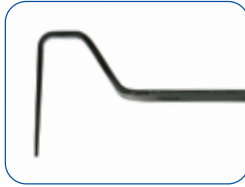

UltraWiz Special Blade „Offset Clearance“ package at 5 pieces

This blade enables cutting around the bottom corners or the bottom edge when the glass is partly covered by fenders and/or the hood. The blade has a cutting length of 25 mm.

Suitable for all pull knives in our range.

■ **UW-1022**



UltraWiz Special Blade „Offset Moulding“ package at 5 pieces

This blade enables you to release a glass from its moulding when the moulding has been bonded to the pinchweld as a result of excessive use of adhesive. The blade cuts between glass and moulding. After cutting just slide the glass down until it can be removed. After that the moulding can be separated from the pinchweld without damage. The blade has a cutting length of 25 mm.

Suitable for all pull knives in our range.

■ **UW-550**

■ **UW-565**



UltraWiz Pull Knife Blade, extra thin, 50 mm long

UltraWiz Pull Knife Blade, 65 mm long

Due to its special length this blade enables you to cut an adhesive bead that is set back from the glass edge.

Suitable for all pull knives in our range.



- **UW-5500**
- **UW-5501**
- **UW-5502**
- **UW-5503**

UltraWiz Interior Pull Knife Blade 13 mm, package at 5 pieces

UltraWiz Interior Pull Knife Blade 19 mm, package at 5 pieces

UltraWiz Interior Pull Knife Blade 25 mm, package at 5 pieces

UltraWiz Interior Pull Knife Blade 32 mm, package at 5 pieces

Finally a blade series that enables you to use your pull knife from inside the vehicle! With these blades you can cut out many side and back glasses with ease.

Don't believe it? Try to cut out the next back glass of a VW Golf III with the 13 mm long blade and you will be surprised. Works also on side glasses.

Suitable for all pull knives in our range.



- **ZKS-150**
- **ZKS-180**

ProGlass Special Pull Knife Blade, 30 mm long, stainless steel, for set back adhesive beads

ProGlass Special Pull Knife Blade, 60 mm long, stainless steel, for set back adhesive beads

The unique double-angled shape of this blades enables you to use a pull knife where you could never use it before!

Typical application area of the 60 mm blade are set back adhesive beads that can be found on the bottom side of many windcreens and that could never be reached with a pull knife blade before.

The 30 mm blade is perfect for all other situations with a body superstructure - meaning that the fenders or the hood are covering the glasses edge, making it impossible to use a 90 degree angled blade.

Suitable for all pull knives in our range.





- **ZK-0119** **Standard Stainless Steel Blade, 19 mm long**
- **ZK-0119-P** **Standard Stainless Steel Blade, 19 mm long package at 5 pieces**
- **ZK-0125** **Standard Stainless Steel Blade, 25 mm long**
- **ZK-0125-P** **Standard Stainless Steel Blade, 25 mm long package at 5 pieces**
- **ZK-0138** **Standard Stainless Steel Blade, 38 mm long**
- **ZK-0138-P** **Standard Stainless Steel Blade, 38 mm long package at 5 pieces**

Well-priced stainless steel blade series. The cutting part of these blades is a little bit thinner and the edge is grinded in a different angle than the stainless series from UltraWiz and REID. Therefore they work with less cutting resistance. Because of the thinner material they also bend and twist more easily when cutting through hard adhesive. Anyway they offer a good cost-performance ratio.

Suitable for all pull knives in our range.

■ **USS-190** **Universal Sharpening Stone with handle**



This sharpening stone with plastic handle is ideal for sharpening all pull knife blades, scraper blades, utility blades and power tool blades.

Working is much easier with a sharp blade!



■ **OM-520**



ProGlass Oscillating Cut-Out Knife „Heavy Duty“ with 1 blade OK-51

- rugged tool for frequent use
- powerful air motor with 22,000 rpm
- backward facing air exhaust with silencer
- safety throttle to avoid an unintended start of the motor
- delivered with hex key for blade exchange
- blade clamp fits all FEIN blades
- air connection 1/4, air consumption 300 l/min
- max. operating pressure 6.2 bar (90 psi)
- net weight: approx. 1.0 kg

■ **OM-610**



ProGlass Oscillating Cut-Out-Knife „Heavy Duty“ with 1 blade OK-51

Extra low vibration drive for non-tiring work under regular and frequent use.

- rugged air motor with 22,000 rpm
- backward facing air exhaust with silencer
- safety throttle to avoid an unintended start of the motor
- delivered with special key for blade exchange with swivelling and removable extra handle
- blade clamp fits all FEIN blades
- air connection 1/4, air consumption 300 l/min
- max. operating pressure 6.2 bar (90 psi)
- net weight: approx. 1.15 kg



■ **OMS-520**

**ProGlass Auto Glass Cut-Out Knife Kit „Heavy Duty“
in plastic case**

Kit contains:

- 1 cut-out knife OM-520
- 1 scraper blade OK-50
- 1 of each cutting blade OK-51, OK-52, OK-53 and OK-54
- 1 foam lined plastic case 340 x 275 x 83 mm



■ **OMS-610**

**ProGlass Auto Glass Cut-Out Knife Kit „Deluxe“
in plastic case**

Kit contains:

- 1 cut-out knife OM-610 with extra handle
- 1 scraper blade OK-50
- 1 of each cutting blade OK-51, OK-52, OK-53 and OK-54
- 1 foam lined plastic case 340 x 275 x 83 mm



■ **OK-50** Scrapper Blade, cranked,
16 mm wide



■ **OK-51** Cutting blade, straight, cranked
cutting depth 50 mm



■ **OK-52** Cutting blade, straight,
cutting depth 35 mm



■ **OK-53** Cutting blade, curved, cranked,
cutting depth 55 mm



■ **OK-54** Cutting blade, straight, cranked
immersion length 90 mm, cutting depth 50 mm



■ **OK-55** Cutting blade, serrated, straight, Blade length 37 mm,
cutting depth 30 mm



■ **OK-56** Cutting blade, straight, Blade length 43 mm,
cutting depth 30 mm



■ **OK-57** Cutting blade, curved 45°, Blade length 43 mm,
cutting depth 27 mm

Robust universal blades for oscillating cutters. Made of hardened stainless steel with a 19 mm double-hexagonal adaptor.

The blades are compatible with the current oscillators from Fein, CP, ProGlass, Rodcraft, Equalizer, etc.



■ 51847

**Viper blade, short, L-shaped
cutting depth 19 mm**



■ 51848

**Viper blade, long, L-shaped
cutting depth 25 mm**



■ 51849

**Viper blade, extra-long, L-shaped
cutting depth 38 mm**

These L-shaped blades are used for cutting out bonded vehicle glasses without damaging the neighbouring pinchweld. At the same time Viper blades are very robust and cut through tough adhesive beads, where other blades just give up and break. Made of hardened steel with a 19 mm double-hexagonal adaptor.

The blades are compatible with the current oscillators from Fein, CP, ProGlass, Rodcraft, Equalizer, etc.



■ DLL-806

**PU Spiral Coiled Air Hose
Inside-Ø 5.0 mm, 10 m long, air connection 1/4"**

Connection hose made of flexible polyurethane. The spiral coiled hose can be extended on up to 80 % of its total length (useable length = 8.50 m).



■ **DG-322**

**Rotary Joint for air hoses
air connection 1/4"**

The rotary joint prevents the air hose from damages or early wear-out. Rotatable at 360°.



■ **DLR-160**

**Air Regulator 11 bar (160 psi)
air connection 1/4"**

Very compact air regulator with pressure gauge to regulate the required working pressure.



■ **PT-321**

**Direct lubricator (not filled)
air connection 1/4"**

This handy lubricator can be placed between air hose and tool and maintains the tool. Your air tool will get the right amount of oil automatically.

Please order additional: Air Tool Oil ATO-100



■ **ATO-100**

Air Tool Oil, bottle at 100 ml

This heavy duty air tool oil can be used for all air tools in our catalogue. Air tools must be oiled daily when used regularly. If you use your tool not regularly you must oil it before and after each use (and run the motor for a few seconds).

The bottle with the long fine tip makes it easy to fill the direct lubricator PT-321.



■ **OC-20M**

Coupler for compressed Air, outside thread R 1/4"



■ **OP-20F**

Air Plug with inside thread R 1/4"

■ **OP-20M**

Air Plug with outside thread R 1/4"



■ **OS-20F**

Air socket with inside thread R 1/4"



■ **OD-20M**

Air socket with outside thread R 1/4"

■ **AFSC-17**

FEIN Battery-Powered SuperCut Automotive AFSC 1.7 Q with quick clamping system, in tool case with accessories



Kit contains:

- 1 FEIN Battery-Powered SuperCut AFSC 1.7 Q
10,000-19,500 1/min, net weight (incl. battery) approx. 1.8 kg
- 1 sharpening stone
- 1 protective cover for tool changes
- 2 Li-Ion battery packs 18 V, 6.0 Ah
- 1 battery charger
- 1 plastic tool case

■ **AFSC-17-A**

FEIN Professional Set For Vehicle Glazing (Battery-Powered)



Kit contains:

- 1 FEIN Battery-Powered SuperCut AFSC 1.7 Q
10,000-19,500 1/min, net weight (incl. battery) approx. 1.8 kg
- 3 L-shaped cutter blades, toothed (FB-207)
- 2 L-shaped cutter blades, toothed (FB-208)
- 1 L-shaped cutter blade, toothed (FB-209)
- 1 hook blade (FB-111)
- 1 hook blade (FB-157)
- 2 hook blades (FB-212)
- 1 straight cutter blade Z-bend, with adjustable stop roller (FB-143)
- 1 straight cutter blade, Z-bend, toothed (FB-081)
- 1 sharpening stone
- 1 protective cover for tool changes
- 2 Li-Ion battery packs 18 V, 6.0 Ah
- 1 battery charger
- 1 plastic tool case

■ **BP-AFSC-17**

Li-Ion Battery 18V, 6.0 Ah for AFSC-17





■ **FEC-417**

**FEIN SuperCut Automotive FSC 1.7,
in tool case with accessories**

Kit contains:

- 1 electronic oscillator 450 W
10,000-19,500 1/min, net weight: approx. 1.45 kg
- 1 blade exchange key
- 1 sharpening stone
- 1 plastic tool case



■ **FEC-417Q**

**FEIN SuperCut Automotive FSC 1.7, with quick clamping
system, in tool case with accessories**

Kit contains:

- 1 electronic oscillator 450 W
10,000-19,500 1/min, net weight: approx. 1.65 kg
- 1 sharpening stone
- 1 plastic tool case

■ **FEC-417Q-A FEIN Professional Set For Automobile Workshops**



Kit contains:

- 1 FEIN SuperCut FSC 1.6Q (FEC-417Q) in plastic tool case
- 2 hook blades (FB-076)
- 1 hook blade (FB-079)
- 1 hook blade (FB-101)
- 2 L-shaped cutter blades, toothed (FB-207)
- 1 L-shaped cutter blade, toothed (FB-208)
- 1 Hook blade, reinforced (FB-157)
- 1 straight cutter blade, Z-bend, with adjustable stop roller (FB-143)
- 1 shovel-shaped scraper blade with scrape protection coating (form 129)
- 1 HSS saw blade Ø 80 mm (FSB-103)
- 1 stopper knife

■ **FEC-417Q-B FEIN Professional Set For Bus and Truck**



Kit contains:

- 1 FEIN SuperCut FSC 1.7Q (FEC-417Q) in plastic tool case
- 2 straight cutter blades, toothed (FB-073)
- 2 straight cutter blade, Z-bend, toothed (FB-081)
- 1 hook-shaped cutter blade, toothed (FB-217)
- 1 curved cutter blade, Z-bend, toothed (FB-072)
- 2 L-shaped cutter blades, toothed (FB-207)
- 1 L-shaped cutter blade, toothed (FB-209)
- 1 hook blade, toothed (FB-212)
- 1 shovel-shaped scraper blade with scrape protection coating (form 105)
- 1 traction cable with fastening



■ **FB-072**

FEIN Cutting Blade
cranked, length 45 mm, package of 2 pieces



■ **FB-073**

FEIN Cutting Blade
toothed, straight, length* 56/35 mm, package of 2 pieces



■ **FB-076**

FEIN Hooked Blade
length 24 mm, package of 2 pieces



■ **FB-079**

FEIN Hooked Blade
length 36 mm, package of 2 pieces



■ **FB-081**

FEIN Cutting Blade
cranked, length* 85/60 mm, package of 2 pieces



■ **FB-101**

FEIN Hooked Blade
length 60 mm, package of 2 pieces



■ **FB-107**

FEIN Hooked Blade
length 60 mm, package of 2 pieces



■ **FB-110**

FEIN Hooked Blade
length 40 mm, package of 2 pieces

* immersion length/cutting length



■ **FB-123**

FEIN Cutting Blade
cranked, length* 110/32 mm, package of 2 pieces



■ **FB-157**

FEIN Hooked Blade,
length 60 mm, package of 2 pieces



■ **FB-174**

FEIN Cutting Blade
cranked, length 27 mm, package of 2 pieces



■ **FB-176**

FEIN Cutting Blade
straight, length* 74/40 mm, package of 2 pieces

■ **FB-194**

FEIN Cutting Blade
straight, length 110 mm, package of 2 pieces



■ **FB-207**

FEIN Cutting Blade, toothed,
L-shaped, length 25.4 mm, package of 2 pieces



■ **FB-208**

FEIN Cutting Blade, toothed,
L-shaped, length 19 mm, package of 2 pieces



■ **FB-209**

FEIN Cutting Blade, toothed,
L-shaped, length 38 mm, package of 2 pieces

* immersion length/cutting length



■ **FB-210**

FEIN Hooked Blade, toothed, reinforced U-shaped, length 19 mm, package of 2 pieces



■ **FB-211**

FEIN Hooked Blade, toothed, reinforced U-shaped, length 25.4 mm, package of 2 pieces



■ **FB-212**

FEIN Hooked Blade, toothed, reinforced U-shaped, length 38 mm, package of 2 pieces



■ **FB-217**

FEIN Hooked Blade, toothed cranked, length 38 mm, package of 2 pieces



■ **FSB-102**

**FEIN Saw Blade
Ø 63 mm, package of 2 pieces**



■ **FSB-103**

**FEIN Saw Blade
Ø 80 mm, package of 2 pieces**

* immersion length/cutting length

■ **AEB-406**



**Equalizer Excalibur Deluxe Kit
in storage case with accessories**

Pneumatic version of the unique Equalizer Auto Glass Cut-Out tool. Cuts almost any car glass from inside the vehicle.

- Powerful 375 Watt air motor with silencer
- 4,200 rpm for fast and vibration-free cutting
- Extremely compact, light-weight and sturdy tool
- Air connection 1/4 inch, air consumption 230 l/min
- max. operating pressure 6.2 bar (90 psi)

Kit contains:

- 1 air-powered „Excalibur“ tool, net weight approx. 1.6 kg
- 2 x 100 mm, 2 x 300 mm, 1 x 200 mm blades
- 1 serrated blade 200 mm
- 1 x 100 mm, 1 x 200 mm, 1 x 300 mm sheath
- 1 pair of safety glasses
- 1 T-handle hex key 1/8 inch
- 1 video instruction (DVD)
- 1 foam lined plastic case 500 x 375 x 175 mm

■ **EEB-793-P**



**Equalizer Blade 100 mm,
package of 5 pieces**

■ **EEB-795-P**



**Equalizer Blade 200 mm,
package of 5 pieces**

■ **EEB-797-P**



**Equalizer Blade 300 mm,
package of 5 pieces**

The classical Equalizer blades have a smooth cutting edge. These blades can be re-sharpened manually with a sharpening stone and have a great service life.

■ **ESB-1304-P**



**Equalizer Serrated Blade 100 mm,
package of 5 pieces**

■ **ESB-1308-P**



**Equalizer Serrated Blade 200 mm,
package of 5 pieces**

■ **ESB-1312-P**



**Equalizer Serrated Blade 300 mm,
package of 5 pieces**

The serrated Equalizer blades are especially recommended for very hard or extremely wide adhesive beads.

■ ATV-2012



quicklink to the product video



Equalizer Ambush 20 V (Equalizer® Express® series)

The Equalizer® Ambush™ is designed to cut through the toughest urethane. A heavy-duty 20-Volt motor provides the power to quickly remove the most difficult glass and with the convenience of the battery, there is no need to worry about finding an electrical outlet or extension cords. It has a rubber over molded comfort grip that allows for optimal comfort and control and a quick release blade clamp that makes it fast and easy to change blades on the fly.

Kit contains:

- 1 Equalizer® Ambush™ Removal Tool
- 1 20-Volt battery DCB-205
- 1 battery charger DCB-105
- 1 Blade BFE-1400
- 1 Instructional DVD
- 1 pair of safety glasses
- 1 heavy-duty plastic carrying case

■ ES-1406



Equalizer® Express® Sheath

The sheath is the unique, patented idea that allows the Equalizer® Express® to use a flexible blade and still have the strength to cut the toughest polyurethane. All Express® tools use the same sheath.

■ EES-804



Equalizer Sheath, length 100 mm

■ EES-808



Equalizer Sheath, length 200 mm

■ EES-812



Equalizer Sheath, length 300 mm

The sheath is the unique, patented idea that makes the Equalizer line of tools work. It guides the blade, regulates the cutting depth and protects the interior.

■ **BFE-1400**

Equalizer® Express® Blade, standard, wide



The Equalizer® Express® Blades were developed from daily use on hundreds of different vehicles. The BFE-1400 is the most used size and is perfect for slicing through wide bands of polyurethane. It works well in all places where you plunge cut or angle cut. The BFE-1401 blade is perfect for removing glass that is not broken. The narrow blade is more flexible and puts less stress on the glass.

■ **EHB-186**

Equalizer® Express® Blade, standard, wide



Express® HydroBlades have a series of small dimples stamped on the side of the blade that rides against the polyurethane. These dimples are designed to carry cutting lubricant into the polyurethane. The cutting lubricant allows for each stroke of the blade to slide easily through the polyurethane. Besides making the blade cut easier they also save battery life and reduce vibration because of the reduced friction on the blade.

■ **MEH-234**

Manual Handle for Express® Blades



With this manual handle you can use any Equalizer Express® Blade as a long knife. The handle is made of aluminum and is 215 mm long (perfect for two handed operation). The blade can be set into the handle at any depth from 20 mm up to 95 mm just by tightening the steel screw into the blade when you have set the blade at the desired depth. Blade not included.

■ **SFE-329**

Equalizer Blade Sharpener



A power tool is only as good as its blade! This blade sharpener is perfect for sharpening all nonserrated Equalizer and BTB blades quickly and easily and is a must for every tool box.



**...not just another
windscreen tool**



**powerful,
light & versatile**

- cuts hard, wide and high polyurethane
- adjustable cutting depth control for every blade
- minimum hand/arm vibration



long blades

easily reach below any dashboard or hard to reach areas



short blades

for good tool control in easy accessible areas



from outside

operates as a powered pull knife that allows cutting from outside for extremely fast removal without physical force



from inside

the flexible and versatile blades follow curved glass as found for example on hatch glasses, safely remove encapsulated glasses



small & versatile

small tool and different blades allow you to work in tight spaces such as small quarter glasses



also for busses and trains

thanks to the variety of blades the BTB tool can be used for the removal of all kind of glasses, panels and mouldings

■ WKSTR-BX BTB Starter Kit (4 blades) in plastic case

Besides the air tool this kit contains a basic assortment of accessories for cutting out bonded glasses on modern vehicles.

Kit contains:

- heavy duty air tool WK10HD, net weight approx. 1.6 kg
- blades: WK2-S, WK4Z-S, WK27S, WK28M
- adjustable cutting depth control arms: WK11BW5, WK11FW
- accessories: WK-KEY, WK7, WK8DSM, WK9, WK11VEL, WK-GA
- training package: users manual, WK12DVD Introduction & Training DVD
- sturdy plastic case



■ WKCLS-BX BTB Classic Kit (7 blades)

Besides the air tool this kit contains an assortment of accessories that enable you to cut out most bonded glasses on modern vehicles with ease.

Kit contains:

- heavy duty air tool WK10HD, net weight approx. 1.6 kg
- blades: WK2-S, WK3, WK24Z-S, WK24ZR-S, WK27S, WK28M, WK6-M
- adjustable cutting depth control arms: WK11AW, WK11BW5, WK11CW, WK11FW
- accessories: WK-KEY, WK7, WK8, WK9, WK11VEL, WK20, WK-GA
- training Package: users manual, WK12DVD Introduction & Training DVD
- sturdy plastic case



■ WKTEC-BX BTB Technician Kit (11 blades)

Besides the air tool this kit contains a comprehensive assortment of accessories for fast and simple cutting out of practically all bonded glasses on modern vehicles.

Kit contains:

- heavy duty air tool WK10HD, net weight approx. 1.6 kg
- blades: WK1-S, WK2-S, WK4-S, WK4Z-S, WK4R-S, WK6-M, WK24Z, WK24ZR-S, WK24R-S, WK27S, WK28M
- adjustable cutting depth control arms: WK11AW, WK11BW5, WK11CW, WK11EW, WK11FW
- accessories: WK-KEY, WK7, WK7L, WK8, WK9, WK11VEL, WK20, WK-GA
- training Package: users manual, WK12DVD Introduction & Training DVD
- sturdy plastic case



■ WKTDM-BX BTB Tradesman Kit (13 blades)

Besides the air tool this kit contains a comprehensive assortment of accessories for fast and simple cutting out of practically all bonded glasses on modern vehicles including commercial vehicles.

Kit contains:

- heavy duty air tool WK10HD, net weight approx. 1.6 kg
- blades: WK1-S, WK3, WK4R-S, WK4Z, WK5-S, WK6-M, WK24Z-S, WK24ZR-S, WK24, WK27S, WK28M, WK27RM, WK28RS
- adjustable cutting depth control arms: WK11AW, WK11BW5, WK11CW, WK11DW5, WK11EW, WK11FW
- accessories: WK-KEY, WK7, WK7L, WK8, WK9, WK11VEL, WK20, WK-GA
- training Package: users manual, WK12DVD Introduction & Training DVD
- sturdy plastic case



■ **WKBTR15-BX BTB Bus, Truck & Rail Kit (15 blades)**



For the bus, truck, rail and commercial vehicle industries, this toolkit contains blades specifically suited to adhesive bonded glass and bonded panel removal on today's transport fleets.

Kit contains:

- heavy duty air tool WK10HD, net weight approx. 1.6 kg
- blades: WK1-S, WK1X, WK2-S, WK4Z-S, WK4ZR-S, WK4-S, WK5-S, WK27S, WK27M, WK27L, WK28S, WK28M, WK28L, WK6-L, WK6-40
- adjustable cutting depth control arms: WK11BW5, WK11DW5, WK11EW
- accessories: WK7, WK7L, WK8DSM, WK9, WK9B, WK11VEL, WK20, WKGA
- training Package: users manual, WK12DVD Introduction & Training DVD
- sturdy plastic case

quicklink to the product video



■ **WK10HD**

BTB Heavy Duty Air Power Tool



- tool only (without blades and accessories)
- exclusive short and fast in-line stroke absorbs reciprocal cutting action of blades
- change blades in less than 10 seconds
- small, powerful and light weight
- cutting depth control system and nylon control head avoids scratching glass or painted panels
- low noise and vibration levels (HAV)
- fully adjustable speed, stroke and power
- motor speed without load max. 6,500 U/min
- air consumption only 140 l/min
- max. operating pressure 6.0 bar

quicklink to the product video



BTB Blade

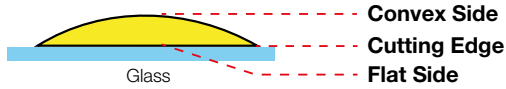

BTB V-Blade

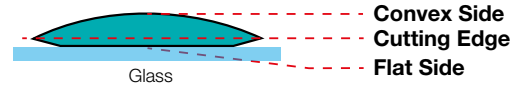

BTB R-Blade

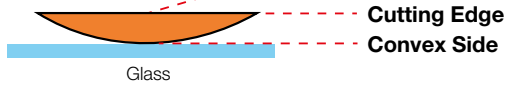

BTB VR-Blade



■ WK1



BTB Long Blade, flat, 300 mm long

■ WK1-S



BTB Long Blade, flat, serrated, 300 mm long

■ WK1-X

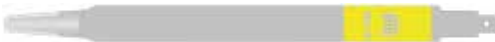

BTB Extra Long Blade, flat, 370 mm long

■ WK1-ZX

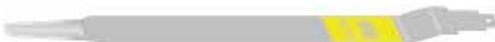

BTB Extra Long Blade, cranked, 370 mm long

■ WK2















BTB Long Blade, flat, 240 mm long

■ WK2-S



BTB Long Blade, flat, serrated, 240 mm long

- 
 WK3 **BTB General Purpose Blade, bent, 200 mm long**
- 
 WK3-S **BTB General Purpose Blade, bent, serrated, 200 mm long**
- 
 WK4 **BTB Blade, bent, flexible blade for curved glass, 190 mm long**
- 
 WK4-S **BTB Blade, bent, serrated, flexible blade for curved glass, 190 mm long**
- 
 WK4Z **BTB Blade, cranked, 140 mm long**
- 
 WK4Z-S **BTB Blade, cranked, serrated, 140 mm long**
- 
 WK5 **BTB Blade, flat, 130 mm long**
- 
 WK5-S **BTB Serrated flat blade, 130 mm long**
- 
 WK24 **BTB Long Blade, bent, flexible blade for curved glass, 240 mm long**
- 
 WK24-S **BTB Long Blade, bent, serrated, flexible blade for curved glass, 240 mm long**
- 
 WK24Z **BTB Blade, cranked, flexible blade for curved glass, 150 mm long**
- 
 WK24Z-S **BTB Blade, cranked, serrated, flexible blade for curved glass, 150 mm long**



- **WK24ZV** BTB V-Blade, cranked, flexible blade for curved surfaces, 150 mm long



- **WK24ZV-S** BTB V-Blade, cranked, serrated, flexible blade for curved surfaces, 150 mm long



- **WK24ZVR-S** BTB Reverse V-Blade, cranked, serrated, flexible blade for curved glass, 150 mm long



- **WK4R-S** BTB Reverse Blade, bent, serrated, flexible blade for curved glass, 190 mm long



- **WK4ZR-S** BTB Reverse Blade, cranked, serrated, 140 mm long



- **WK24R-S** BTB Reverse Blade, bent, serrated, flexible blade for curved glass, 240 mm long



- **WK24ZR-S** BTB Reverse Blade, cranked, serrated, flexible blade for curved glass, 150 mm long



- **WK4ZV-S** BTB V-Blade, cranked, serrated, for curved glass 140 mm long



- **WK4ZVR-S** BTB VR-blade, cranked, serrated, sharpened on the rear side 140 mm long



- **WK5Z-S** BTB Blade, cranked, serrated, 120 mm long



- **WK5ZR-S** BTB Reverse Blade, cranked, serrated, 120 mm long



- **WK27S** BTB Left Hand Power Cold Knife Blade, 19 mm tip length
- **WK27M** BTB Left Hand Power Cold Knife Blade, 25 mm tip length
- **WK27L** BTB Left Hand Power Cold Knife Blade, 30 mm tip length
- **WK27XL** BTB Left Hand Power Cold Knife Blade, 45 mm tip length
- **WK27RM** BTB Left Hand Power Cold Knife Blade, reverse blade, 25 mm tip length

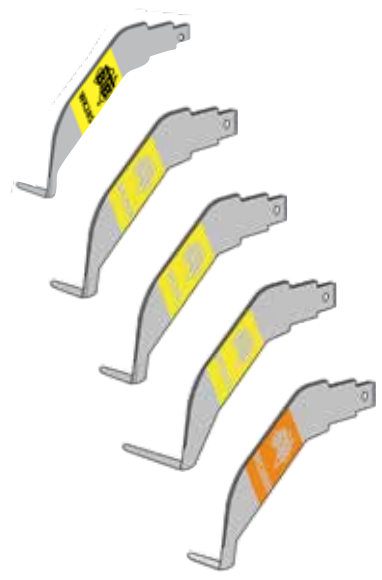

- **WK28S** BTB Right Hand Power Cold Knife Blade, 19 mm tip length
- **WK28M** BTB Right Hand Power Cold Knife Blade, 25 mm tip length
- **WK28L** BTB Right Hand Power Cold Knife Blade, 30 mm tip length
- **WK28XL** BTB Right Hand Power Cold Knife Blade, 45 mm tip length
- **WK28RM** BTB Right Hand Power Cold Knife Blade, reverse blade, 25 mm tip length



- **WK11PP** BTB Paint Protector for BTB Power Cold Knife Blades



■ **WK16LR** BTB Moulding Release Blade



■ **WK17-4** BTB Backfill Removal Blade
4 mm blade channel width

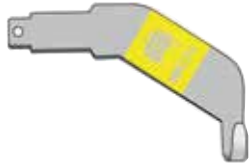

■ **WK17-6** BTB Backfill Removal Blade
6 mm blade channel width



■ **WK18Z** BTB Spade Blade, cranked,
140 mm long, wide spade shape



■ **WK18ZS** BTB Spade Blade, cranked, serrated,
140 mm long, wide spade shape

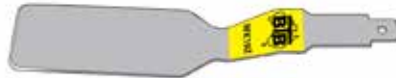

■ **WK19Z** BTB Spade Blade, cranked,
180 mm long, wide spade shape



■ **WK19ZS** BTB Spade Blade, cranked, serrated,
180 mm long, wide spade shape

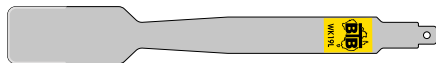

■ **WK19L** BTB Spade Blade, straight,
180 mm long, wide spade shape



■ **WK19L-S** BTB Spade Blade, straight, serrated,
180 mm long, wide spade shape



■ **WK6-SET**

BTB Pinchweld Scraper Set in 6 parts

BTB Pinchweld Scraper Set, including the following components:



- 1 scraper blade 15 mm wide (WK6-S)
- 1 scraper blade 20 mm wide (WK6-M)
- 1 scraper blade 25 mm wide (WK6-L)
- 1 scraper blade 40 mm wide (WK6-40)
- 1 manual handle (WK7)
- 1 universal key (WK-KEY)

■ **WK6-N-SET**

BTB Pinchweld Scraper Set in 6 parts

The BTB Pinchweld Scraper Set with 6 parts allow a easy cut back from the polyurethane in curves and corners at the car body because of his tapered shaft.



Kit contains:

- 1 Scraper blade 15 mm wide (WK6-SN)
- 1 Scraper blade 19 mm wide (WK6-MN)
- 1 Scraper blade 25 mm wide (WK6-LN)
- 1 Scraper blade 40 mm wide (WK6-40N)
- 1 Manual handle (WK7)
- 1 Universal key (WK-KEY)

■ **WK6-MXN**

BTB special winged pinchweld scraper blade, 20 mm wide 150 mm long

Pinchweld Scraper Blade with curved end. Thereby the special shape reduces the risk of damaging the paint compared to standard scraper blades. The blades are suitable for our handle Part. No. WK7.





- **WK6-S** BTB Winged Pinchweld Scraper Blade, 15 mm wide
- **WK6-M** BTB Winged Pinchweld Scraper Blade, 20 mm wide
- **WK6-L** BTB Winged Pinchweld Scraper Blade, 25 mm wide
- **WK6-40** BTB Pinchweld Scraper Blade, 40 mm wide



- **WK6-SN** BTB Special Winged anti-scratch pinchweld Scraper Blade, tapered Shaft 15 mm wide
- **WK6-MN** BTB Special Winged anti-scratch pinchweld Scraper Blade, tapered Shaft 20 mm wide
- **WK6-LN** BTB Special Winged anti-scratch pinchweld Scraper Blade, tapered Shaft 25 mm wide
- **WK6-40N** BTB Pinchweld Scraper Blade, tapered Shaft 40 mm wide



■ **WK7**

Manual Blade Handle for BTB blades



■ **WK7L**

Manual Blade Double Handle for BTB blades

With the manual blade handle and the manual blade double handle you can use all BTB blades also manually.

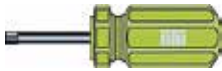

■ **WK-KEY**

BTB Universal Key

Handy screwdriver for the blade clamping screw on the BTB tool.





■ CE-119

Clip Remover, flat/narrow

Clip Remover with flat and narrow nose for removing all kind of plastic clips. Ergonomically shaped, two-component ProGlass handle, shaft made of solid metal.

Total length: approx. 210 mm



■ CEG-1410

Clip Remover flat/wide

Clip Remover with flat and wide nose for removing all kind of plastic clips. Ergonomically shaped, two-component ProGlass handle, shaft made of solid metal.

Total Length: 220 mm



■ CE-657

Clip remover, small

A clip remover with a particular narrow and fine tip. With the pointedly approaching v-notch, it is especially suitable for very small clips at newer vehicle models.

Total Length: 195 mm



■ CEG-148

Clip Remover „Pig Foot“, wide

Simple Clip Remover for door coverings. For easy removal of door coverings without damaging the plastic clips.

Total Length: 230 mm



■ **CE-607**

Clip-Remover, angled

This clip remover is ideal for the removal of cowling clips in recessed holes and areas.

Total Length: 195 mm



■ **CE-590**

Clip Removal Tool

Very flat clip removal tool for all kind of clips with a reach of 10 cm even for clips far underneath the door lining. The other side has a reach of 5 cm and offers thereby a larger lever force.

Total Length: 230 mm



■ **CES-125**

Clip-Remover Kit, in 2 parts

The two clip removal tools in this kit have a fine tip and are very strong at the same time. They help you to remove all those small clips that were almost impossible to reuse because you were never able to remove them without damage.

Total Length: 155 mm



■ **CZ-540**

**Clip Removal Pliers
to dismantle clips and linings**

Clip pliers for professional removal of plastic clips, no scratches or dents at the coachwork. Dismantling of door linings without damage.

Total Length: 240 mm



■ **BMR-1488**

Belt Moulding Remover



When removing a belt moulding it is important that you can save it. This tool slides down into the door opening and pulls out the moulding easily without any damage.



■ **CES-250**

Clip Remover Kit, in 5 parts

These five tools made of polished steel cover the whole range of door and lining clips. With this kit you can remove almost all clips fast, easily and without damage.



■ **CDZ-195**

Clip Pliers

Thanks to the specially designed jaws these pliers can also remove very flush installed clips and two-part clips.

Total Length: 195 mm



■ **CS-696**

**TrimClip Pliers
to dismantle clips and linings**

Pliers with extra flat jaws with 3 different recesses. Each type and size of clips can be grabbed easily and safely.

Total Length: 210 mm

■ **CE-749**

Special Tool for C-Clips

For the removal of 'C'-shaped clips on window handles (e. g. Opel).



■ **MHD-110**

Double Mini Hook, set of 2 pieces

These mini hooks have a long reach and can help you to adjust rubber mouldings where all other hook tools are simply too big. They are also great little helpers to pick up small pieces.

Total Length: 225 mm



■ **MHK-069**

Ball-tipped Mini Hook Set, in 4 parts

These ball-tipped mini hooks are very helpful where standard-sized ball-tipped hooks do not work. The ball diameter of each tool is 3.0 mm.

Total Length: 130 mm



■ **MHS-068**

Hook and Pick Set, in 4 parts

These mini hooks are only about 130 mm long. They are very helpful where 'normal' hook tools do not work.

Total Length: 130 mm



■ **CEK-180**

Clip & Strip Remover
Total Length: 180 mm



■ **CEK-215**

Clip & Strip Remover
Total Length: 215 mm



■ **LHK-160**

Trim Jack 160 mm long, 60 mm wide



■ **DHS-360**

Dismantling Lever Set, made of plastic, in 5 parts

Dismantling of clips, trims and linings with metal tools, often causes damages like scratches. Therefore this five parts tool is completely made of sturdy and loadable plastics. It is a must for each car glass workplace.



■ **HBS-027**

**Trim & Clip Remover Kit in 27 parts,
with blow moulded plastic case**

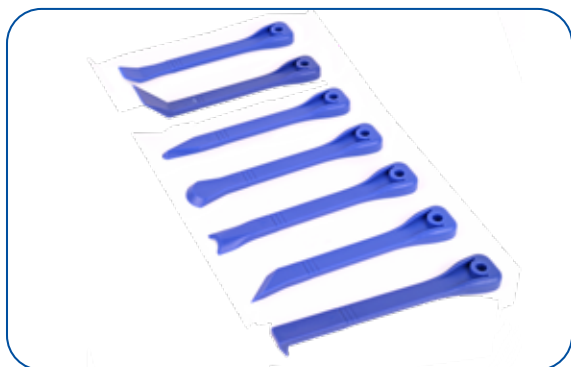



■ **LEC-SET1**

Clip and Strip Remover Kit, in 4 parts

4 straight clip and weather strip removers made of durable plastics.

Kit contains:

- 1 weather strip remover, flat (item no. LEC-175F)
- 1 straight clip remover, L-shaped (item no. LEC-175FL)
- 1 straight clip remover, V-shaped (item no. LEC-175FV)
- 1 straight clip remover, Z-shaped (item no. LEC-175FZ)



■ **LEC-175F**

Weather Strip Remover, flat

Total Length: 175 mm



■ **LEC-175FL**

Straight Clip Remover, L-shaped

Total Length: 175 mm



■ **LEC-175FV**

Straight Clip Remover, V-shaped

Total Length: 175 mm



■ **LEC-175FZ**

Straight Clip Remover, Z-shaped

Total Length: 175 mm



■ **LEC-SET2**

Clip and Strip Remover Kit, in 3 parts

3 bent clip and weather strip removers made of durable plastics.

Kit contains:

- 1 weather strip remover, bent (item no. LEC-175G)
- 1 bent clip remover, U-shaped (item no. LEC-175GU)
- 1 bent clip remover, V-shaped (item no. LEC-175GV)



■ **LEC-175G**

Weather Strip Remover, bent

Total Length: 175 mm



■ **LEC-175GU**

Bent Clip Remover, U-shaped

Total Length: 175 mm



■ **LEC-175GV**

Bent Clip Remover, V-shaped

Total Length: 175 mm



■ **MS-205**

Installation Stick Pointed/Round plastic, 205 mm long

This installation stick is the perfect tool for dismantling those damageable plastic covers from rear view mirrors and cameras.



■ **MS-180**

Installation Stick round/flat of ivory coloured plastic, 200 mm long

The round end of the plastic installation stick is appropriate for working on rubber mouldings or render a fresh PU bead, the fl at scraper end is good to use for cleaning and removing excessive polyurethane. A tool with almost unlimited applications.



■ **MS-181**

Installation Stick round/round of ivory coloured plastic, 200 mm long

Plastic installation stick with two rounded ends for working on rubber mouldings or render a fresh PU bead. A tool with almost unlimited applications.



■ **IWH-692**

Handle with installation stick round/round

Handle with one installation stick with 2 round ends (like MS-181). The installation stick is fastened with a set screw.



■ **ISH-691**

Handle for installation stick

Hollowed out handle to hold an installation stick MS-180 or MS-181. The installation stick is fastened with a set screw.



■ MSL-265**Installation Lever flat/clip made of plastic, 265 mm long**

Long lever tool with one flat-angle wedge end and one clip lever end.

**■ DLH-511****Moulding Release Tool with two hook ends**

Classical moulding release tool with two hook ends. Rubber spacers at the bottom avoid scratches on glass or varnishing.

**■ LH-230****Trim Jack, heavy duty model**

Heavy duty trim jack for removing tight metal trims and all other hardly to remove mouldings. Total length 230 mm.

**■ RFM-683****Trim Jack**

Mainly used to remove re-usable trims. The wide and flat form as well as the curvature enables to lift the trim without damaging. In addition it is perfect to lever simple rubber or plastic mouldings or trims with a metal core. Total length 205 mm.





■ **BND-2882**

Blind Rivet Pliers with twistable head

Some rivets are put into places that are almost inaccessible. This tool has a 360° twistable head that works in all directions. By that the nose can reach almost everywhere. Comes with four different nose pieces and a wrench to change them.



■ **BNZ-2685**

Blind Rivet Pliers, standard

Standard riveting tool with an extended nose length. Thanks to the long nose this tool lets you install rivets in vehicle doors with ease. Comes with four different nose pieces and a wrench to change them.



■ **BN-308**

Blind Rivets, 3.0 x 8 mm, package at 50 pieces

■ **BN-326**

Blind Rivets, 3.2 x 6 mm, package at 50 pieces

■ **BN-408**

Blind Rivets, 4.0 x 8 mm, package at 50 pieces

■ WAS-700



Universal Wiper Arm Puller Set

- No. 1 Alfa-Romeo, Audi, BMW, Citroen, Fiat, Ford, Honda, Jaguar, Mazda, MG-Rover, MB, Mitsubishi, Opel, Peugeot, Renault, Seat, Skoda, Volvo, VW, Mercedes, Chevrolet
- No. 2 Alfa-Romeo, Audi, BMW, Citroen, Fiat, Ford, Honda, Hyundai, Jaguar, Land Rover, MB, Opel, Peugeot, Renault, Saab, VW, Mercedes, Chevrolet
- No. 3 Alfa-Romeo, Audi, BMW, Fiat, Citroen, b Ford, Mazda, MB, Mitsubishi, Opel, Peugeot, Smart, Volvo, VW, Chevrolet
- No. 4 Citroen, Hyundai, MB, Opel, Mercedes, Chevrolet
- No. 5 Alfa-Romeo, Audi, BMW, Ford, Jaguar, Land Rover, Mazda, MB, Volvo, VW
- No. 6 Citroen, Ford, Peugeot

■ EWA-1702



Wiper Arm Puller Easy Lift

shank width: 18 mm, working height: 32 mm

This wiper arm puller is trouble-free applicable under casted air deflectors. It can also be used for nearly all other types of wipers. Made of specially hardened steel.

■ HWA-2636



Wiper Arm Puller "EasyLift II"

shank width: 26 mm, working height: 38 mm

The EasyLift II fits for Audi models from 2001. The wiper arm puller is designed for heavy use. It also offers a brass cap to protect the wiper arm thread against damage.



■ **WAF-1535**

**Wiper Arm Puller with flexible shank width
15-35 mm, working height 40 mm**

Heavy wiper arm puller for almost all BMW series and Rolls Royce RR1 and RR2.

Also perfect for many other cars!



15 mm - 35 mm



■ **DWR-120**

**Wiper Arm Puller, Heavy Duty
shank width: 16 mm, working height: 38 mm**

Extremely loadable wiper arm puller. For use on almost all passenger cars and many commercial vehicles. Especially recommended for the BMW E34 (5) and E32 (7) series, that have wipers with adjustable inclination.



■ **WAB-150**

**Wiper Arm Puller BMW
shank width: 23 mm, working height: 37 mm**

Heavy wiper arm puller for BMW from series E32/E34. This tool is designed very similar to the original BMW tool and has exactly the same function.



■ **WAS-1630**



**Universal-Wiper Arm Puller
shank width 16 mm, working height 30 mm**

The wiper arm puller impresses with its filigree, slim and robust design and can therefore be used universally. The large star grip makes it easy to pull off the wiper arms without additional tools! The puller is designed for very high loads. It also has a brass cap to protect the thread of the wiper arm shaft.



■ **WAN-3650**

Wiper Arm Puller Audi Q7
shank width: 36 mm, working height: 16 mm

Compact and very robust wiper arm puller, especially designed for the wiper arm of the Audi Q7 and other models with similar wiper arm construction.



■ **SWA-2316**

Standard Wiper Arm Puller
shank width: 16 mm, working height: 26 mm

A universal wiper arm puller with clamping screw for easy handling (without extra tool). Suitable for many vehicles.



■ **ZAW-090**

Wiper Arm Puller, universal
shank width: 38 mm, working height: 28 mm

A sturdy tool for use on almost all passenger cars and many commercial vehicles, because of a large-scale adjustment to pull of the wipers.



■ **WAV-899**

Wiper puller Volkswagen Group
shank width: 63 mm, working height: 33 mm

Suitable for most models from the Volkswagen group and many others. To protect the wiper arm bolt the large screw is hollow. So to use this tool the wiper arm nut must be loosened, but must remain on the bolt. By that the screw of the tool is holding up against the nut.



■ **UAZ-1950**

Wiper Arm Puller, heavy-duty
shank width: 18 mm, working height: 48 mm

Real heavy universal puller for various jobs - also fits for many wiper arms.



■ **WAZ-919**

Wiper Arm Pliers

Multi-purpose pliers to remove most standard wiper arms. Not suitable for heavy load.



■ **GH-701**

Rubber Hammer Ø 50 mm
weight: 380 gr

Almost indispensable tool to install mouldings and linings.



■ **GPZ-225**

Grip Pliers, 225 mm long

- Straight grip pliers made of chromoly steel (CrMo)
- Holds round, profile and flat material securely
- With adjustment screw and release lever for one-hand operation
- High clamping pressure due to toggle lever action
- Holding capacity 0-30 mm



■ **RMP-416**

**Installation Pliers
for rearview mirrors with bayonet clamp**

With these pliers you can easily remove and install all rearview mirrors with bayonet clamp (e. g. most VW and Audi models). No risk of damaging the windscreen or the mirror.



■ **RMP-416-1**

**Replacement Plastic Jaws for (1 pair) RMP-416
(not shown)**



■ **MB-743**

**Rearview Mirror Screwdriver
TORX T15 / TORX T20**



■ **MB-744**

**Rearview Mirror Screwdriver
hex driver 2.0 mm / hex driver 2.5 mm**



■ **MBR-600**

**Rearview Mirror Screwdriver
TORX T15 / Phillips PH1**



■ **SDM-421**

Mini Screwdriver Set

Who doesn't know that! You can see the screw but no screwdriver can reach into the narrow space above the screw head. That's a job for the only 3.4 cm long mini screwdrivers! The set contains 2 Phillips screwdrivers (PH0, PH1) and 2 slotted screwdrivers (5 mm, 6 mm).



■ **BHS-058**



1/4 Inch Bit Set with Bit Holder and Mini Ratchet

Universal Bit-Set made of robust chrome-vanadium steel. The mini ratchet win over by a very low shape hereby it's perfect usable in small and narrow areas. Delivered in a sturdy plastic box (165 x 110 x 37 mm) with molded insert.

- | | | | |
|--|------------------------------------|--|--|
| | PH 0 / 1 / 2 / 3 | | 3 / 4 / 5,5 / 6,5 |
| | PZ 0 / 1 / 2 / 3 | | T 7 / 8 / 9 / 10 / 15 / 20 / 25 / 27 / 30 / 40 |
| | 6 / 8 / 10 | | STX 7 / 8 / 9 / 10 / 15 / 20 / 25 / 27 / 30 / 40 |
| | SW 2 / 2,5 / 3 / 4 / 5 / 6 / 7 / 8 | | IPR 10 / 15 / 20 / 25 / 27 / 30 / 40 / 45 / 50 |
| | XZN M5 / M6 / M8 | | |

■ **MSP-2030**

Nut Splitter Set

If a nut is so damaged that you can not open it you should have a nut splitter available. The smaller one has an eye diameter of 20 mm, the bigger one of 30 mm. Total length is 117 resp. 150 mm.





■ STS-039

Socket Set 1/4 drive in 39 parts

Made of robust chrome-vanadium steel. Delivered in a sturdy plastic box (245 x 130 x 44 mm) with molded insert.

Kit contains:

- 1 ratchet wrench (72 teeth)
- 1 hand grip
- 1 short extension
- 1 large extension with toggle function
- 1 cardan joint
- 13 hexagon sockets (4/4,5/5/5,5/6/7/8/9/10/11/12/13/14)
- 4 cross-head bits (PH1/PH2/PZ1/PZ2)
- 2 slotted bits (5,5 / 7)
- 5 hexagon I-keys (1,2/1,5/2,0/2,5/3,0)
- 3 allen insert (4/5/6)
- 7 Torx (T8/T10/T15/T20/T25/T27/T30)



■ RSS-0819

Ratchet Wrench Set of 7 pieces

- The professional ratchet mechanism has a gear with 72 teeth (5° returning angle) and allows you to work on narrow places.
- With their small ring end side these wrenches are the perfect alternative to classical ratchets and nuts.
- The wrenches conform to ANSI standard. However, opening very hard fixed screws with the gear-side could break the gear mechanism.
- The set includes the wrench sizes 8, 10, 12, 13, 14, 17 and 19 mm.
- Delivered on a wall-mountable plastic support.



■ **HLK-012**

Lift Support Clamp

This clamp enables you to fix old pneumatic springs of bonnets or hatches. Open the bonnet up to the desired angle, attach the clamp - fix it - ready.



■ **THH-540**

**Telescopic Bonnet Holder
made of aluminum, in 3 parts**

■ **THH-540-G**

Set of Replacement Rubber Caps for THH-540

Keeps the bonnet or hatch open at any desired angle. The telescopic bonnet holder is stepless adjustable from 54 to 120 cm.





■ **SSH-290**

Window Holder Set

Holds the side window while you are working on the window lifter so that you have both hands free. Very stable due to cast-in thread. Cable length 45 cm.



■ **LB-300**

Power-Lifter inflatable bag 15 x 20 cm

The PowerLifter facilitates detaching bonded glasses, regardless of the method used. You place the bag at an already detached point between the glass and the car body and inflate it. Lifting the glass, stretches the remaining PU bead, which can now be much easier detached. The bag is made of fibre-reinforced fabric, which is extremely tough and loadable. Only at about 150 kg the pressure-relief valve opens.





■ **AMM-880**



Car installation magnet Ø 88 mm

Very powerful fitting magnet with rubber coating for harmless working on metallic car body panels. For fitting from moulding, trim, emblem and foil.



■ **FIX-080-P**

■ **FIX-080**

Moulding Clamp, red, package at 6 pieces

Moulding Clamp, red, single

This version has a long slotted hole instead of the three single fixing holes. So it can be easier positioned. The PVC suction cup with a diameter of 80 mm holds on glass as well as on metal.

Versatile capabilities:

- retains freshly bonded mouldings, badges or mirror plates
- press on freshly bonded vehicle glazings (e. g. if the upper corners do not align properly)
- prevents freshly bonded vehicle glazings from sagging (fix the sucker to the window to hold it up against the roof)







■ **FSK-300**

ProGlass Pinchweld Scraper Kit in plastic case, with long scraper tool

Kit contains:

- 1 pinchweld scraper, long (like item no. FSC-300)
- 10 blades 12 mm wide (item no. SC-313)
- 10 blades 16 mm wide (item no. SC-316)
- 10 blades 20 mm wide (item no. SC-320)
- 1 foam lined plastic case (240 x 215 x 45 mm)

■ **FSK-150**

ProGlass Pinchweld Scraper Kit in plastic case, with short scraper tool (not shown)

Same like FSK-300, but instead of a long scraper tool it comes with a short scraper tool (like item no. FSC-150).

The blades of this pinchweld scraper are sharp like razor blades. The practical clamping mechanism enables a very quick blade exchange without using any tools.

■ **FKM-145**

Pinchweld Scraper Kit in plastic case, with short scraper tool and utility knife

Useful set including a pinchweld scraper tool and a utility knife with numerous replacement blades.



Kit contains:

- 1 pinchweld scraper 150 mm long
- 5 blades 12 mm wide (like item no. SC-313)
- 5 blades 16 mm wide (like item no. SC-316)
- 5 blades 20 mm wide (like item no. SC-320)
- 5 blades angled, 16 mm wide (like item no. SCA-316)
- 1 utility knife
- 5 trapezoid blades (in dispenser, like item no. TK-10)
- 1 plastic case (240 x 160 x 50 mm)





■ **WRD-SKB**



WRD Pinchweld Scraper Kit in plastic case, with long scraper tool & sharpening stones

The WRD Pro Scraper system offers a safe standard in pinchweld preparation. The different high-grade razor blades designed specific for the task, with the convenient diamond sharpening solution you get a complete system.

■ **FSC-120**



**ProGlass Scraper with quick change system
120 mm long, with 5 blades 16 mm wide**

Aluminium pinchweld scraper without handle for fine cutting jobs. The practical clamping mechanism enables a very quick blade exchange without using any tools.

Includes 5 pieces of the 16 mm wide blade (like item no SC-316).

■ **FSC-150**



**ProGlass Pinchweld Scraper with quick blade exchange
150 mm long**

Pinchweld scraper with ergonomically shaped, non-skid handle and short shaft. The practical clamping mechanism enables a very quick blade exchange without using any tools.

Includes 5 pieces of the 16 mm wide blade (like item no SC-316).

■ **FSC-300**



**ProGlass Pinchweld Scraper with quick blade exchange
190 mm long**

Pinchweld scraper with ergonomically shaped, non-skid handle and long shaft. The practical clamping mechanism enables a very quick blade exchange without using any tools.

Includes 5 pieces of the 16 mm wide blade (like item no SC-316).



- **SC-313**
- **SC-316**
- **SC-318**
- **SC-320**
- **SCA-316**

Scraper Blades 12 mm, package at 10 pieces
Scraper Blades 16 mm, package at 10 pieces
Scraper Blades 18 mm, package at 10 pieces
Scraper Blades 20 mm, package at 10 pieces
Scraper Blades angled, 16 mm wide, package at 10 pieces

Our high-grade stainless steel scraper blades are optimized for the use with our tools FSC-120, FSC-150 and FSC-300. But they also fit with tools from other manufacturers.

For perfect results the grinded side of the blade faces to the body. By driving the tool in the correct angle you will get a constantly thin layer of remaining material. Damages to the car body can be really avoided.

TIP:
 By pulling the loose end of the adhesive bead the blades will cut the material even easier.



■ **SCE-007** **Parer Blade, 7 mm wide, max. cutting depth 9 mm**



■ **SCE-012** **Parer Blade, 12 mm wide**



■ **SCR-006** **Parer Blade, Ø 6 mm**



■ **SCR-012** **Parer Blade, Ø 12 mm**

These parer blades are especially good for cleaning the pinchweld from excessively applied polyurethane in curves and corners. Thereby the special shape reduces the risk of damaging the paint compared to standard scraper blades. The blades are suitable for our scraper tools FSC-120, FSC-150 and FSC-300.



- **SRB-09**
- **SRB-12**
- **SRB-17**



Pinweld scraper blade, 9 mm wide

Pinweld scraper blade, 12 mm wide

Pinweld scraper blade, 17 mm wide

The special shape significantly reduces the risk of damaging the paint in comparison to standard scraper blades.

The blades are suitable for our scraper tools FSC-120, FSC-150, FSC-300 and FMK-145.



- **SC-313E**
- **SC-316E**
- **SC-320E**



Economy Scraper Blades 12 mm, package at 10 pieces

Economy Scraper Blades 16 mm, package at 10 pieces

Economy Scraper Blades 18 mm, package at 10 pieces

■ **GS-380**

Glass Scraper with plastic handle, for 40 mm wide blades



Wide scraper with long handle for comfortable use. With its 40 mm wide, razor sharp blades this tool is dedicated to remove labels and to clean glasses from residues.

All metal parts are made of stainless steel. Delivered with 1 blade and a protective cover for safe storage when not in use.

■ **GS-120**

Glass Scraper with retractable blade, for 40 mm wide blades



Wide scraper with retractable blade for safe use and transportation. With its 40 mm wide, razor sharp blades this tool is dedicated to remove labels and to clean glasses from residues.

All metal parts are made of stainless steel or brass-plated. Includes 1 blade.

■ **RK-100A**

Scraper blades 40 mm wide, package at 100 pieces



Top quality industrial blades with a thickness of 0.009 (=0.23 mm) and a solid metal back. Each blade has a single paper wrapping in the box to prevent you from injuries.

■ **RK-100B**

Economy Scraper blades 40 mm wide, package at 100 pieces



Inexpensive industrial blades in thickness 0.009 (approx. 0.23 mm). Each blade individually packed in the box.

■ **RK-100HD**

Heavy Duty Scraper blades 40 mm wide package of 100 pieces



Heavy Duty industrial blades with a thickness of 0.012 (=0.30 mm) and a solid metal back. Each blade has a single paper wrapping in the box to prevent you from injuries.





■ **MS-6**

Mini Scrapers, package of 6 pieces (sorted colours) for 40 mm wide blades

The mini scrapers are simply practical and can be used for a million different things!

When not in use, the blade can be flipped so that the metal backed part faces outside. Like that the scraper can be carried in the pocket and is always on hand. Includes 1 blade per piece.



■ **RKK-10**

Plastic Razor Blades, package at 10 pieces

These plastic razor blades are good for removing stickers and labels from glass surfaces. As the blade is made of plastic it cannot scratch the glass like a metal blade could.



■ **FGS-140**

Flat Glass Scraper with 1 blade, 89 mm wide

■ **RK-8905**

Razor blades for FGS-140, package of 5 pieces

This extra wide glass scraper with its retractable 89 mm wide blade is perfectly suited for removing large labels and stickers or window films.





■ **FSL-213**

**ProGlass Pinchweld scraper with neoprene cover
13 mm wide, exchangeable blade**

■ **FSL-216**

**ProGlass Pinchweld scraper with neoprene cover
16 mm wide, exchangeable blade**

■ **FSL-219**

**ProGlass Pinchweld scraper with neoprene cover
19 mm wide, exchangeable blade**

Standard pinchweld scraper tool (total length: 250 mm) with neoprene cover. The spring steel blade can be re-sharpened and, if necessary, be replaced.



■ **FSS-213**

**Pinchweld Scraper with aluminium handle
13 mm wide, exchangeable blade**

■ **FSS-216**

**Pinchweld Scraper with aluminium handle
16 mm wide, exchangeable blade**

■ **FSS-219**

**Pinchweld Scraper with aluminium handle
19 mm wide, exchangeable blade**

Well-priced pinchweld scraper tool (total length: 240 mm). The spring steel blade can be re-sharpened and, if necessary, be replaced.



■ **SK-113**

Scraper blade, 13 mm wide, 140 mm long

■ **SK-116**

Scraper blade, 16 mm wide, 140 mm long

■ **SK-119**

Scraper blade, 19 mm wide, 140 mm long

Spring steel pinchweld scraper blades suitable for all pinchweld scrapers of this page and many standard pull knives.

NOTE: The 13 and 16 mm wide blades do not fit with quick release pull knives.



■ **FSK-003**

Pinchweld Scraper Set, in 3 parts

Set with three different pinchweld scrapers. Fixed blades made of polished spring steel.

- 1 blade approx. 100 mm long, 16 mm wide
- 1 blade approx. 50 mm long, 20 mm wide
- 1 blade approx. 50 mm long, 13 mm wide



■ **SKS-003**

Scraper Set, in 3 parts

Set with three different scrapers. Fixed blades made of polished spring steel. Metal cap at the rear end of the handle.

- 1 blade approx. 100 mm long, 50 mm wide
- 1 blade approx. 100 mm long, 32 mm wide
- 1 blade approx. 100 mm long, 32 mm wide, bent



■ **UCH-319**

U-Groove Parer Knife with pull handle

With the round shape of its blades this knife is able to clean excessive polyurethane from the pinchweld where a normal pinchweld scraper will not work. Two different wide blades let you cut narrow or wide grooves.

Includes one small and one large blade.



■ **UCC-320**

U-Groove Parer Knife without pull handle

Includes one small and one large blade.



■ **UCL-322**

Wide Parer Blade, for UCH-319 and UCC-320

width of cut: approx. 9 mm depth of cut: approx. 18 mm



■ **UCS-321**

Small Parer Blade, for UCH-319 and UCC-320

width of cut: approx. 7 mm depth of cut: approx. 18 mm

■ **BK-315****Banana Knife with serrated blade
total length 320 mm**

The blade is serrated on the inside and sharpened on the outside. With its bent shape it is ideal to cut a polyurethane bonding where pull knives or cut-out tools will not work (e. g. the lower corners of a windscreen that are often covered by the wings). Thanks to its long narrow blade it has an extremely good reach and outmatches a standard long knife.

■ **BK-230****Replacement Blade for Banana Knife BK-315**■ **LM-460**■ **LM-610****ProGlass Long Knife 460 mm long****ProGlass Long Knife 610 mm long**

Rugged long knife made of aluminium with a non-skid neoprene covered handle. Integrated spare blade compartment. Includes 2 trapezoid blades.

■ **UMS-437**

Utility Knife AMERICAN-LINE



This light-weight and handy utility knife with black painted aluminium handle has a fully retractable blade, a multi-step blade length adjustment and offers a spare blade compartment inside the handle. The solid blade holder inside is also made of metal so the blade will not slip out under heavy use. Includes 1 trapezoid blade.

■ **TK-10**

Trapezoid Blades, dispenser at 10 pieces



■ **TKS-100**

Trapezoid Blades, dispenser at 100 pieces



The dispenser lets you easily withdraw new blades individually. Used blades are inserted at the top of the dispenser and so they are safely put away.

■ **XUB-05**

Trapezoid Blades, extra long, package at 10 pieces



The cutting length of these blades is 95 mm while standard trapezoid blades are only 60 mm long. This blade increases the range by 60 mm!

NOTE: When using a retractable blade knife these extra long blades will not be retracted completely.

■ **CMK-170**

Cutter knife with automatic blade magazine



Cutter knife for 18 mm blades with integrated and automatic blade magazine for a maximum of 6 x supplied blades.

■ **SVR-2**



Olfa® Silver Knife for 9 mm blades with 3 snap-off blades

Knife and blades are made of stainless steel - therefore this is the ideal tool for the installation of window films.

■ **OL-40**



Olfa® Knife for 9 mm wide blades with 1 snap-off blade

A small and handy knife with 9 mm wide snap-off blades for all fine jobs.

■ **MESSER-C**



Cutter Knife 9 mm with ProGlass-Logo Print with 1 snap-off blade

A small and handy knife with 9 mm wide snap-off blades for all fine jobs with ProGlass logo and imprint:

www.proglass.de

■ **NTC-400**



NT Cutter Knife for 9 mm wide blades with 1 snap-off blade

Very handy and narrow cutter knife, which impresses with its length of 185 mm. The quick retraction mechanism ensures fast, stress-free and safe work.



■ **AB-10**

Olfa® Snap-Off Blades 9 mm package at 10 pieces



■ **ASBB-10**

Olfa® Snap-Off Blades extra sharp, 9 mm wide, package at 10 pieces



■ **ABB-50**

Olfa® Snap-Off Blades extra sharp, 9 mm wide package at 50 pieces



■ **AB-10S**

Olfa® Snap-Off Stainless Steel Blades 9 mm package at 10 pieces



■ **AB-50S**

Olfa® Snap-Off Blades (stainless steel), 9 mm wide, package at 50 pieces



■ **SAB-10**

Olfa® Graphic Snap-Off Blades, 30°, 9 mm wide, package at 10 pieces

■ **MT-1**

Olfa® Knife for 12.5 mm wide blades with 1 snap-off blade



■ **MTB-10B**

Olfa® Snap-Off Blades, 12.5 mm wide, package at 10 pieces



■ **FWB-10**

Olfa® Snap-Off Blades extra sharp, 12.5 mm wide, package at 10 pieces



■ L-2

Olfa® Knife for 18 mm wide blades with 1 snap-off blade



■ XL-2

Olfa® Long Knife for 18 mm wide blades with 1 snap-off blade



■ ABK-10



Snap-Off Blades, 18 mm wide, package at 10 pieces



■ LB-10

Olfa® Snap-Off Blades 18 mm, package at 10 pieces

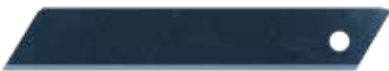

■ LBB-10

Olfa® Snap-Off Blades extra sharp, 18 mm wide package at 10 pieces



■ LBB-50



Olfa® Snap-Off Blades extra sharp, 18 mm wide package at 50 pieces



■ LSOL-10

Olfa® Solid Blades 18 mm, not segmented, package at 10 pieces



■ H-1

Olfa® Extra Heavy Duty Cutter 25 mm
with 1 snap-off blade



■ HB-5

Olfa® Snap-Off Blades 25 mm
package at 5 pieces



■ HBB-5B

Olfa® Snap-Off Blades extra sharp, 25 mm wide
package at 5 pieces



■ HOK-1

Olfa® Hook Cutter



■ HOB-1

Olfa® Hooked Blade, single

■ **CK-2**



Olfa® Knife with 20 mm blade

Solid cutting knife with 1 blade off stainless steel. Blade with a length of cut over 55 mm, beveled up 45°, grindable, and a locking screw for latching.

■ **CKB-2**



Olfa® Blades 20 mm wide

20 mm stainless steel blade with a cutting length of 55 mm bevelled to 45°, resharpenable and stainless.

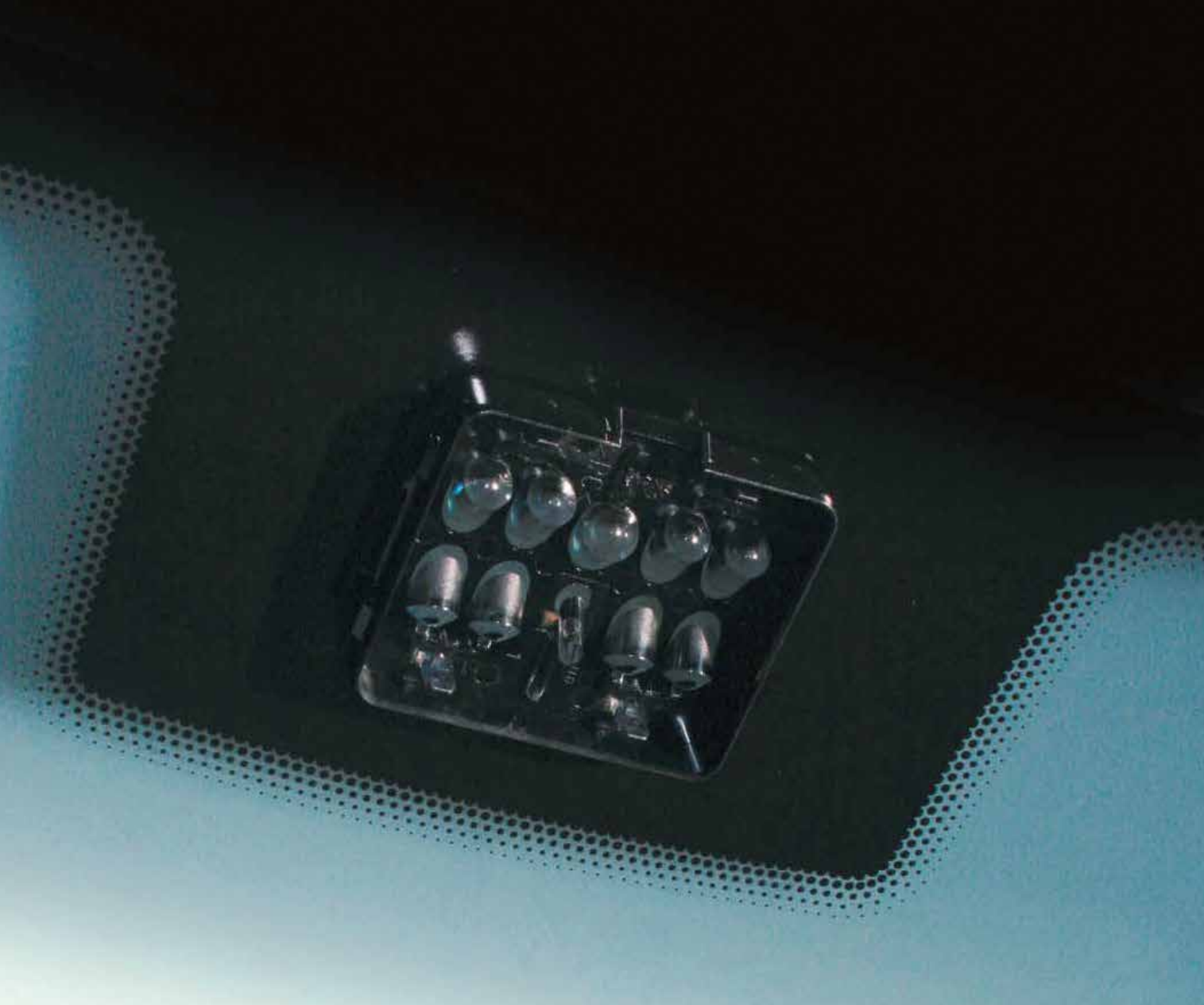

Rain, Light and Air Con Sensors in best quality from OE manufacturers

The basic version of more and more vehicles is already equipped with a rain or light sensor. Since 2003 BMW additionally uses an anti-fogging sensor which controls the air conditioning system.

Indeed it is possible in most cases to transfer the optical unit from the old to the new windscreen, but therefore the adhesive pad - means the crystal clear bond between optical unit and windscreen - has to be renewed. Depending on the model, this can be very time consuming. It is faster

and easier to use a new optical unit (all our optical units are already equipped with an adhesive pad).

To ensure a faultless function of the extensive controlling electronics you should solely use genuine parts. Reproductions which can be found on the market can eventually lead to installation problems or even malfunction.



■ SOR-199

Rain Sensor for Alfa Romeo, BMW, Mercedes, Rover

Vehicle Type	Eurocode	YOC
Alfa 147	2037	2001 -
Alfa 166	2036	1998 -
BMW E38	2433	1994 - 2001
BMW E39	2434	12/1995 - 09/2001
BMW E46 Lim./Coupé	2436	1998 - 09/2001
BMW E53 X5	2439	04/2000 - 09/2001
Mercedes W129 SL	5331	1989 - 2001
Mercedes W140 S-Class	5333	1991 - 1998
Mercedes W202 C-Class	5334	03/1993 - 05/2000
Mercedes W203 C-Class	5351	05/2000 - 04/2003
Mercedes W203 Sport Coupé	5352	03/2001 - 06/2003
Mercedes W208 CLK	5341	1997 - 2002
Mercedes W210 E-Class	5337	1995 - 2002
Mercedes W215 CL	5345	03/1999 -
Mercedes W220 S-Class	5344	1998 - 08/2002
Mercedes W230 SL	5346	2001 -
Rover 75	7035	06/1999 - 01/2004



■ SOL-192A Light and Rain Sensor for Mercedes, Nissan, Renault

Vehicle Type	Eurocode	YOC
Mercedes BM639 Viano / Vito	5438	09/2003 -
Nissan GT-R	6053	2008 -
Nissan Micra K12	6011	02/2003 -
Nissan Murano Z51	6051	2008 -
Nissan Note	6041	2006 -
Nissan Pathfinder / Navara	6037	2005 -
Nissan Qashqai	6044	2006 -
Nissan Tiida	6046	2007 -
Nissan X-Trail	6047	2007 -
Renault Scénic / Grand Scénic	7257	06/2003 -
Renault Modus	7263	07/2004 -



■ SOL-192C Light and Rain Sensor for BMW, Renault

Vehicle Type	Eurocode	YOC
BMW E60/E61 5-er	2445	04/2007 -
BMW E70 X5	2452	02/2007 -
BMW F07 5-er GT	2461	2009 -
BMW F07 5-er	2459	2010 -
Renault Mégane III	7279	10/2007 -
Renault Kangoo II	7474	2008 -
Renault Laguna III	7273	2008 -



■ SOL-192D Light and Rain Sensor for Fiat, Mercedes, Smart, VW

Vehicle Type	Eurocode	YOC
Fiat Ducato III	3750	07/2006 -
Mercedes BM906 Sprinter	5439	06/2006 -
Mercedes W169 A-Class	5358	2004 -
Mercedes W171 SLK	5356	2004 - 2010
Mercedes W245 B-Class	5358	2005 -
Smart ForTwo	5368	2007 -
Smart ForFour	5359	2004 -
Smart Roadster	5355	2003 -
VW Crafter	8590	04/2006 -



■ SOL-189 Light and Rain Sensor for Citroen, Mercedes, Peugeot

Vehicle Type	Eurocode	YOC
Citroen C-Crosser	2738	2007 -
Mercedes W204 C-Class	5364	2007 -
Mercedes W212 E-Class	5371	2009 -
Mercedes W207 E-Class Coupé	5370	2009 -
Mercedes GLK	5369	2008 -
Peugeot 4007	6555	2007 -

Detailed vehicle type allocation table on our website at www.proglass.de or upon request!



■ **SOL-193A** **Light and Rain Sensor for BMW and Mazda**

Vehicle Type	Eurocode	YOC
BMW E39 5-er Limousine	2434	09/2001 - 06/2003
BMW E39/2 5-er Touring	2434	09/2000 - 02/2004
BMW E46/2 3-er Coupé	2437	01/1999 - 05/2006
BMW E46/2C 3-er Cabrio	2437	12/1999 - 11/2006
BMW E46/3 3-er Touring	2436	06/1999 - 08/2005
BMW E46/4 3-er Limousine	2436	01/1998 - 03/2005
BMW E53 X5 - SUV	2439	09/2001 - 11/2006
BMW E65 7-er	2443	10/2001 - 03/2003
BMW E83 X3 - SUV	2449	09/2003 - 08/2007
Mazda 2 (J37L)	5173	2007 -
Mazda 3 (J48C)	5166	2003 -
Mazda 6 (J50C)	5164	2005 -



■ **SOL-193B** **Light and Rain Sensor for BMW**

Vehicle Type	Eurocode	YOC
BMW E46 Compact	2442	06/2001 - 08/2001
BMW E60 5-er Limousine	2445	03/2003 -
BMW E61 5-er Touring	2445	03/2004 -
BMW E63 6-er Coupé	2446	09/2003 -
BMW E64 6-er Cabrio	2446	12/2003 -
BMW E87 1-er Limousine	2448	06/2004 -
BMW E90 3-er Limousine	2447	12/2004 -
BMW E91 3-er Touring	2447	06/2005 -
BMW E92 3-er Coupé	2454	06/2006 -
BMW E93 3-er Cabrio	2450	12/2006 -
BMW Z85 Z4 Roadster	2444	02/2003 -
BMW Z85 Z4 Coupé	2453	03/2006 -



■ **SKA-502** **Anti-Fogging Sensor for BMW**

Vehicle Type	Eurocode	YOC
BMW E60/E61 5-er	2445	2003 -
BMW E63/E64 6-er	2446	2004 -
BMW E65 7-er	2443	2003 -
BMW E87 1-er	2448	2004 -
BMW E90 3-er	2447	2005 -



■ **SKA-502M** **Fit-Up Aid for BMW Anti-Fogging Sensor**

Vehicle Type	Eurocode	YOC
BMW E60 5-er	2445	2003 -
BMW E63/64 6-er	2446	2004 -
BMW E65 7-er	2443	2003 -
BMW E87 1-er	2448	2004 -
BMW E90 3-er	2447	2005 -

Detailed vehicle type allocation table on our website at www.proglass.de or upon request!

Gel Pads for LRS (light and rain sensors)

While in the nineties most sensors had a separate optical unit that was bonded to the glass, the trend nowadays goes to integrated models. These sensors combine the electronic and optical unit in one compact box. When a windscreen is replaced the whole box is taken over to the new glass. These sensors are no longer bonded to the glass, but the optical unit is only joint on to it with a gel pad which can be replaced easily in case of a windscreen exchange.

How to proceed:

Take off the sensor box from the old windscreen. To do this it is either sufficient to dismount the rearview mirror or to release the retaining bracket. Afterwards the sensor box can be removed from the glass without effort (Pay attention to sensors with opaque silicone pads! These sensors can stick to the glass very tightly and it is very likely to damage the silicone pad. To remove such a sensor we recommend to heat the glass from the outside with a hot air gun - this will help to remove the silicone pad together with the sensors more easily and without damage).

When removing the sensor box in most cases the gel pad will be destroyed. This is why the vehicle manufacturers have specified that the sensor pad must be renewed every time the sensor has been dismounted (this is especially important for crystal clear gel pads). The gel residue can be removed easily by rubbing them off manually. If required you can use a mild cleaner with high alcohol content (e. g. our applicator KPA-250). Please let evaporate thoroughly! Then place the right gel pad on the clean sensor surface and mount the sensor box to the new windscreen.

ATTENTION: The applicator KPA-250 must not be used with our gel pads. The high alcohol content would affect the material. If you need to use a liquid applicator you can use clear water or a liquid glass cleaner with a low alcohol content.



■ **GPL-154**

Gel Pads for rain/photosensor Mazda, Lexus, Subaru, Toyota, Package at 5 pieces

■ **GPL-154-1**

Gel Pads for rain/photosensor Mazda, Lexus, Subaru, Toyota, Package at 1 piece

Dimensions: 26 x 34 x 2.0 mm

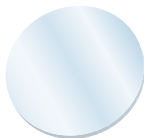

■ **GPL-166**

Gel Pads for rain/photosensor Seat, Skoda, VW, Package at 5 pieces

■ **GPL-166-1**

Gel Pads for rain/photosensor Seat, Skoda, VW, Package at 1 piece

Dimensions: Ø 32 x 1.5 mm

Detailed vehicle type allocation table on our website at www.proglass.de or upon request!

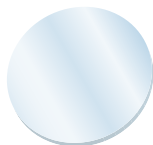

■ **GPL-168**

Gel Pads for rain/photosensor Audi, BMW, Buick, Cadillac, Chevrolet, Ford, Opel, Package at 5 pieces

■ **GPL-168-1**

Gel Pads for rain/photosensor Audi, BMW, Buick, Cadillac, Chevrolet, Ford, Opel, Package at 1 piece

Dimensions: Ø 31 x 1.5 mm



■ **GPL-190**

Gel Pads for rain/photosensor Audi, Alfa, Fiat, Ford, Volvo, Toyota, Opel, Seat, Package at 5 pieces

■ **GPL-190-1**

Gel Pads for rain/photosensor Audi, Alfa, Fiat, Ford, Volvo, Toyota, Opel, Seat, Package at 1 piece

Dimensions: 27 x 32.5 x 1.5 mm



■ **GPL-191**

Gel Pads for rain/photosensor Alfa, Citroen, Fiat, Mercedes, Porsche, Skoda, Toyota, VW, Package at 5 pieces

■ **GPL-191-1**

Gel Pads for rain/photosensor Alfa, Citroen, Fiat, Mercedes, Porsche, Skoda, Toyota, VW, Package at 1 piece

Dimensions: Ø 27 x 1.5 mm

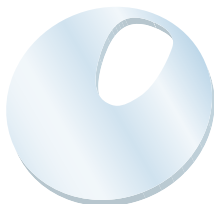

■ **GPL-192**

Gel Pads for rain/photosensor Fiat, Ford, Mercedes, Nissan, Renault, Setra, Package at 5 pieces

■ **GPL-192-1**

Gel Pads for rain/photosensor Fiat, Ford, Mercedes, Nissan, Renault, Setra, Package at 1 piece

Dimensions: Ø 44 x 2.5 mm

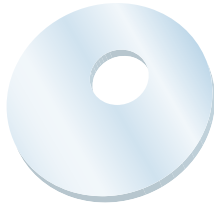

■ **GPL-192C** Gel Pads for rain/photosensor BMW, Nissan, Renault, Smart, Package at 5 pieces

■ **GPL-192C-1** Gel Pads for rain/photosensor BMW, Nissan, Renault, Smart, Package at 1 piece

Dimensions: Ø 43 x 2.5 mm

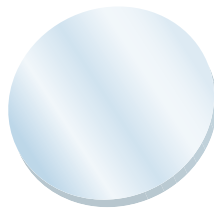

■ **GPL-194** Gel Pads for rain/photosensor MAN, Mercedes, Neoplan, Scania, VDL, Package at 5 pieces

■ **GPL-194-1** Gel Pads for rain/photosensor MAN, Mercedes, Neoplan, Scania, VDL, Package at 1 piece



Dimensions: Ø 44 x 3 mm



■ **PSG-001** ProGlass Sensor Gel 4 ml

Sensor gel for the regeneration of the gel pad of all light and rain sensors with crystal clear silicone pad.

Two-component special silicone gel for one complete refill of a big sensor, like e. g. on Renault Espace, MB Sprinter or BMW 5 series (our item no. SOL-192...).

If the repair gel is not used completely at once, for example when filling a smaller sensor, immediately remove the mixing nozzle and seal the syringe with the original cap. Additional mixing nozzles are available under item no. PSG-MD10.

■ **PSG-MD10** Mixing Nozzle for Sensor Gel, package at 10 pieces



■ **PSG-004Q**



ProGlass Quick Sensor-Gel 4 ml

Quick Sensor gel for the regeneration of the gel pad (in only 4 minute) of all light and rain sensors with crystal clear silicone pad. Two-component special silicone gel for three complete refill of three big sensor, like e. g. on Renault Espace, MB Sprinter or BMW 5 series (our item no. SOL-192...).

If the repair gel is not used completely at once, immediately remove the mixing nozzle and seal the syringe with the original cap. Additional mixing nozzles are available under item no. PSG-MD10-K.



■ **PSG-012Q**

ProGlass Quick Sensor-Gel 12 ml

Quick Sensor gel for the regeneration of the gel pad (in only 4 minute) of all light and rain sensors with crystal clear silicone pad. Two-component special silicone gel for three complete refill of three big sensor, like e. g. on Renault Espace, MB Sprinter or BMW 5 series (our item no. SOL-192...).

If the repair gel is not used completely at once, immediately remove the mixing nozzle and seal the syringe with the original cap. Additional mixing nozzles are available under item no. PSG-MD10-K.



■ **PSG-MD10-K**

Mixing Nozzle for Sensor Gel package at 10 pieces, 50 mm long



■ **RSL-330**

Rain Sensor Level

Easily adjustable level for perfect alignment of the sensors to be filled. By leveling the sensor body, a 100% even filling is achieved.



Replacement Adhesive Pads for rain and light sensors

For more and more vehicles a rain or light sensor is already part of the standard equipment. When exchanging a windscreen, the optical unit of the sensor is also often being replaced, though it is not necessary. Our special adhesive pads, made of entirely transparent, self-adhesive material, enable you to reuse the optical unit.

How to proceed:

First remove the optical unit carefully from the glass with an installation stick or a sensor removal tool. As most of the optical units are made of plastic, they must not get in contact with solvent based cleaners. It is best to peel off the remaining glue with the fingers. For the final cleaning, use a cleaner that

evaporates without residue and does not corrode the plastic, e.g. our primer/cleaner **HRS-100**. Now first stick on the adhesive pad to the optical unit and then the whole part to the windscreen. For bubble-free, perfect results use our applicator **KPA-250**.

By the way, our adhesive pads are also suitable for many sensors with a gel pad. On our website you can find an instruction how to proceed in that case. Upon request our sales staff will also be happy to send it to you.



Light/Rain Sensor Adhesive Pad for Toyota Dimensions: 25 x 34 x 2.0 mm

- **KPL-154** Package at 5 pieces
- **KPL-154-1** Package at 1 piece

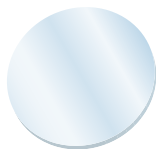

Light/Rain Sensor Adhesive Pad for Seat, VW Dimensions: Ø 32 x 1.5 mm

- **KPL-166** Package at 5 pieces
- **KPL-166-1** Package at 1 piece

Detailed vehicle type allocation table on our website at www.proglass.de or upon request!



Light/Rain Sensor Adhesive Pad for Honda, Kia, Opel, Saab
Dimensions: 40 x 27 x 1.0 mm

■ **KPL-185** Package at 5 pieces

■ **KPL-185-1** Package at 1 piece



Light/Rain Sensor Adhesive Pad for Citroen, Mercedes, Peugeot
Dimensions: 40 x 35 x 1.5 mm

■ **KPL-189** Package at 5 pieces

■ **KPL-189-1** Package at 1 piece



Light/Rain Sensor Adhesive Pad for Chrysler, Jeep
Dimensions: 40 x 35 x 1.0 mm

■ **KPL-189B** Package at 5 pieces

■ **KPL-189B-1** Package at 1 piece



Light/Rain Sensor Adhesive Pad for Alfa, Audi, Opel, Porsche, Seat, Toyota
Dimensions: 27 x 32.5 x 1.5 mm

■ **KPL-190** Package at 5 pieces

■ **KPL-190-1** Package at 1 piece

Detailed vehicle type allocation table on our website at www.proglass.de or upon request!



Light/Rain Sensor Adhesive Pad for Citroen, Fiat, Mercedes, Nissan, Peugeot, Renault, Smart, VW

Dimensions: Ø 43 x 2.0 mm

■ **KPL-192** Package at 5 pieces

■ **KPL-192-1** Package at 1 piece



Light/Rain Sensor Adhesive Pad for BMW, Renault

Dimensions: Ø 43 x 2.0 mm

■ **KPL-192C** Package at 5 pieces

■ **KPL-192C-1** Package at 1 piece



Light/Rain Sensor Adhesive Pad for BMW, Chrysler, Citroen, Dodge, Jeep, Landrover, Mazda, Mercedes, Peugeot, Range Rover

Dimensions: 55 x 33 x 1.5 mm

■ **KPL-193** Package at 5 pieces

■ **KPL-193-1** Package at 1 piece



Light/Rain Sensor Adhesive Pad for Mercedes

Dimensions: 70 x 42 x 1.5 mm

■ **KPL-197** Package at 5 pieces

■ **KPL-197-1** Package at 1 piece

Detailed vehicle type allocation table on our website at www.proglass.de or upon request!



Rain Sensor Adhesive Pad for Chevrolet, Honda, Hyundai, Kia, Opel,
Dimensions: 40 x 28 x 1.0 mm

- **KPR-188** Package at 5 pieces
- **KPR-188-1** Package at 1 piece

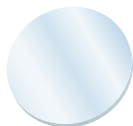

Light/Rain Sensor Adhesive Pad for Citroen, Fiat, Lancia, Mercedes, Peugeot
Dimensions: Ø 27 x 1.5 mm

- **KPR-191** Package at 5 pieces
- **KPR-191-1** Package at 1 piece



Light/Rain Sensor Adhesive Pad for VW Group until YOC 98
Dimensions: Ø 28 x 1.0 mm

- **KPR-194** Package at 5 pieces
- **KPR-194-1** Package at 1 piece



Rain Sensor Adhesive Pad for Alfa, BMW, Mercedes, Rover
Dimensions: 56 x 31 x 1.5 mm

- **KPR-199** Package at 5 pieces
- **KPR-199-1** Package at 1 piece

Detailed vehicle type allocation table on our website at www.proglass.de or upon request!

■ **KPA-250**

**Applicator for Adhesive Pads and Acrylic Tapes
Spray bottle at 250 ml**



The applicator helps you to avoid air locks when sticking on sensor pads and adhesive tapes with acrylic adhesive (all items of our range with an item number starting with KPR-, KPL-, TAC-, TAB-).

The liquid applicator enables you to correct the position after sticking the sensor to the glass.

ATTENTION: The applicator KPA-250 must not be used with our gel pads. The high alcohol content would affect the material. If you need to use a liquid applicator you can use clear water or a liquid glass cleaner with a low alcohol content.

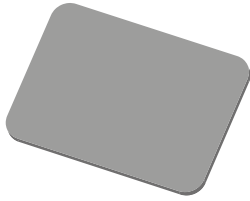

Adhesive Pad for Toll Collect Device
Dimensions: 52 x 37 x 0.8 mm

- **KPM-3752** Package at 5 pieces
- **KPM-3752-1** Package at 1 piece

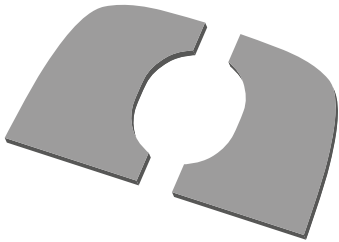

Adhesive Pads for camera holder for IVECO EUROCARGO & DAF XF
Dimensions: 51 x 41 x 2 mm

- **KPM-4151** Package at 5 pieces
- **KPM-4151-1** Package at 1 piece

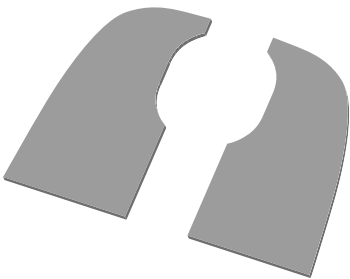

Adhesive Pads for camera holder for DAF / IVECO / VOLVO
Dimensions: 69 x 41 x 2 mm

- **KPM-4169** Package at 5 pieces
- **KPM-4169-1** Package at 1 piece

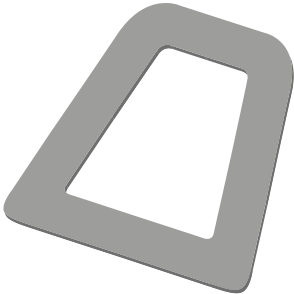

Toll Collect DSRC Adhesive Pad
Dimensions: 64 x 44 x 1,6 mm

- **KPM-4464** Package at 5 pieces
- **KPM-4464-1** Package at 1 piece

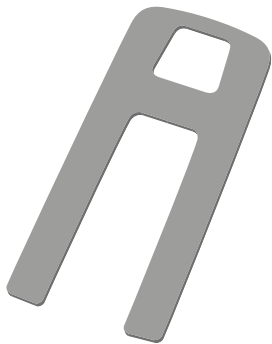

**Adhesive Pad for sensor / camera holder for lane assistant
SCANIA R & S series**
Dimensions: 100 x 50 x 1,6 mm

- **KPM-5010** Package at 5 pieces
- **KPM-5010-1** Package at 1 piece

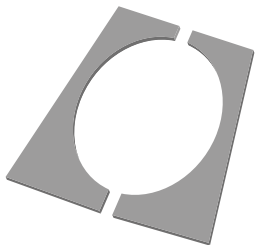

**Adhesive Pad for camera holder
MAN TGA L/M, XL & MB Actros**
Dimensions: 62 x 60 x 1,5 mm

- **KPM-6260** Package at 5 pieces
- **KPM-6260-1** Package at 1 piece



**Adhesive Pad for sensor / camera holder for lane assistant
MAN TGA L/M, XL, XXL**
Dimensions: 132 x 74 x 1,1 mm

- **KPM-74132** Package at 5 pieces
- **KPM-74132-1** Package at 1 piece



**Adhesive Pad for camera holder
for lane assistant MB Actros**
Dimensions: 74 x 74 x 1,6 mm

- **KPM-7474** Package at 5 pieces
- **KPM-7474-1** Package at 1 piece

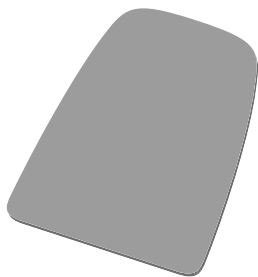
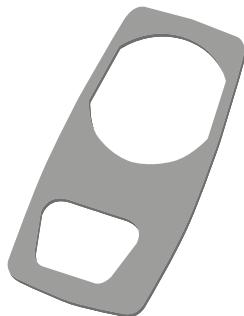
**Adhesive Pads for antenna holder****Dimensions: 164 x 80 x 1,6 mm**■ **KPM-7488** Package at 5 pieces■ **KPM-7488-1** Package at 1 piece**Adhesive Pad for sensor / camera holder for lane assistant MB Actros****Dimensions: 164 x 80 x 1,6 mm**■ **KPM-80164** Package at 5 pieces■ **KPM-80164-1** Package at 1 piece



■ **SL-350-C**

Windscreen Lift up to 3.50 m height for busses, trucks and trains

The ProGlass Windscreen Lift facilitates the fitting of big and heavy windows on busses, trucks or trains.

The model SL-350-C has a suction unit with three suction cups with an overall load capacity of 280 kg. The lift has a total height (extended) of approx. 3.50 m. This is even high enough to exchange the top windscreen on big coaches.

The whole construction can be easily folded down for transportation in a service truck. Thanks to the integrated transportation casters this can be done by a single person (total weight 154 kg). All functions are mechanical (no external power source necessary) - only lifting and lowering of the window can be supported sensible by using a cordless screwdriver (not included!).

By using the Windscreen Lift the manpower requirements for the glazing of big vehicles can be reduced by minimum one person. Therefore it will pay for itself within short time. At the same time the use of this equipment significantly reduces the physical stress and the risk of injuries for the technicians.

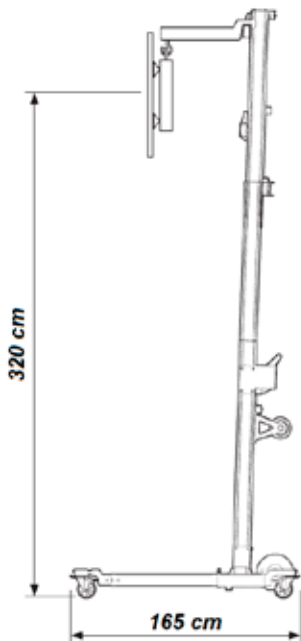



■ **SL-350-ZV1 Extension 830 mm for Windscreen Lift**

The 830 mm long extension arm is perfect for the installation of the upper windscreen on a Neoplan Cityliner or Starliner II. With this extension you can tilt the windscreen to the needed setting angle of 45 degrees.

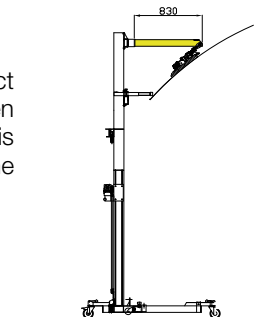

■ **SL-350-ZV2 Extension 1,540 mm for Windscreen Lift**

With the 1,540 mm long extension arm and the long supports the lift can also be used for the installation of windscreens on vans and smaller trucks.



■ **SL-350-ZS1 Overturning System for Windscreen Lift**

For turning the glass from horizontal to installation position with a cordless screwdriver. ATTENTION: Can only be used in connection with the extension 830 mm (SL-350-ZV1) / 1540 mm (SL-350-ZV2).



■ **SL-350-ZM1 Motor Kit for Windscreen Lift**

Gear motor with wire controller for supplementary installation. The cable length of the wire controller is 5.20 m. With industrial socket IEC 309 (200 - 250 V, 16 A, IP44). Power cord not included!

■ **SL-300-S**

**Windscreen Lift up to 3.00 m height
for busses, trucks and trains**

The ProGlass Windscreen Lift facilitates the fitting of big and heavy windows on busses, trucks or trains.

The model SL-300-S has a suction unit with two suction cups with an overall load capacity of 140 kg. The lift has a total height (extended) of approx. 3.00 m. This is high enough to install the windscreen on most busses and trucks.

The whole construction can be easily folded down for transportation in a service truck. Thanks to the integrated transportation casters this can be done by a single person (total weight 120 kg). All functions are mechanical (no external power source necessary) - only lifting and lowering of the window can be supported sensible by using a cordless screwdriver (not included!).

By using the Windscreen Lift the manpower requirements for the glazing of big vehicles can be reduced by minimum one person. Therefore it will pay for itself within short time. At the same time the use of this equipment significantly reduces the physical stress and the risk of injuries for the technicians.

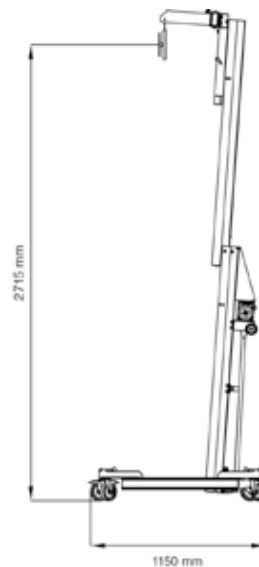

■ PFN-300

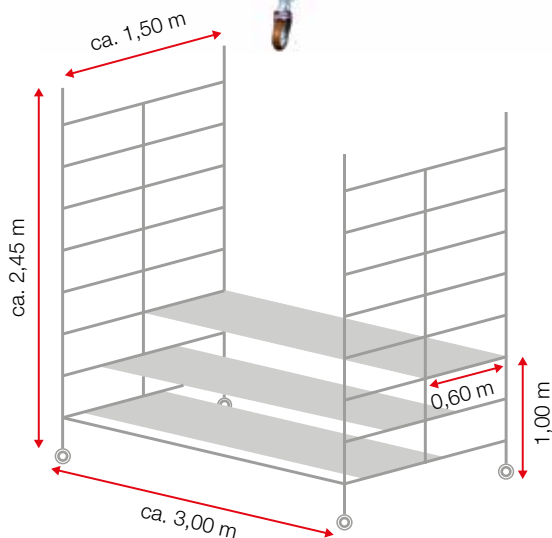

Mobile Scaffold for bus and truck work

Finally a safe working space for the glazing of busses and trucks!

The construction platform with its 4 big swivelling castors (\varnothing 150 mm, gummed, with brake) can be positioned easy and in a safe manner. In addition, all castors are vertically adjustable to adapt the scaffold on uneven ground.

Two fitters can comfortably move the windscreen to the vehicle: They both have enough space to stand on the platform as it is 3.0 m wide. The steps are fixed on the levels of 50, 75 and 100 cm.

Assembly and disassembly of the scaffold is quick and easy to handle without the use of tools. The maximum weight of a single part is of only 24 kg, so that it can be done completely by one person.

total weight: 121 kg

loading length (max.): 3.07 m

loading height (max.): 1.54 m

- the ideal scaffold for the glazing of busses and trucks
- working height ca. 3 m
- TÜV approved, load capacity 200 kg/m² (scaffold class 3) in accordance with EN1004
- the platform size with 2.90 m x 0.60 m offers a safe working space
- all parts are easy to handle (max. weight 24 kg)
- quick assembly without the use of tools thanks to the patented locking system

■ PFK-050



Work Platform StepTop, max. load 150 kg

- foldable work platform with water-proof and non-slip phenolicresin panel (109 x 30 cm)
- ideal for working on vans and small trucks (height of platform: 50 cm)
- safety locks on both sides prevent unintentional folding
- multiple riveted robust aluminum step/rail joints with 4 additional stable corner braces
- quick and space-saving storage (13.5 cm thick)
- non-slip, large dimensioned foot caps ensure safe foothold

■ **WPRO6-3IN1-D WRD PRO6 System 3-in-1, Deluxe Kit**



This is the latest all-in-one solution from WRD Glass Tools for the removal, transportation and installation of bonded vehicle glasses. Each of the three vacuum pump suction lifters has a different configuration, which makes this multifunctional tool kit extremely versatile. This is probably the most compact and professional tools solution for the up-to-date windscreen removal with cutting line and cordless drill (similar to the famous SPIDER removal system) and the back-friendly installation of bonded windscreens by only one person. At the same time the suction lifters can be used for the safe handling and transportation of all glasses.

Scope of delivery as shown on picture!

■ **WPRO6-INS4 WRD PRO6 Installation System with 4 suction lifters**



Kit contains:

- 4 vacuum pump suction lifters WPRO6-B
- 1 extended arm WPRO6-EA
- 1 double hook kit WPRO6-DH
- 1 tool tote WPRO6-TT
- 1 instruction manual

Maximum load 20 Kg



The installation system from the WRDglass Tools PRO6 series allows simple installation of windscreens by just one person. The ingenious system is suitable for car and van windscreens and allows windscreens to be fitted to almost any model of vehicle. This also includes severely curved windscreens, or those covered by car body parts.

The system is uniquely compact with 4 suction cups and three system accessories. This makes it the perfect mobile solution for one-man installation - both as a mobile service or in the workshop.

*quicklink to the
product video*



POWER PUSH



7

Auto Glass Installation

■ **APP-5420**

Power Push Cordless Caulking Gun 20 V for 310 ml cartridges and sachets up to 400 ml



- short 400 ml clear barrel for sausage packs
- Incredibly high squeezing pressure of 4700 N for a simple processing of highly viscous material
- Up-to-date lithium-ion battery technology for maximum performance at a minimum weight (power tool including battery 2.28 kg)
- highest application accuracy of all battery guns on the market
- Variable speed trigger for optimal control
- Vmax restriction on 6-speed wheel (feed rate 0 - 9 mm/s)
- Remaining content easily visible by the position of the rack
- No dripping of sealant thanks to electronic rack release function after disengaging the trigger
- Rack disengages automatically for fast reloading
- Ergonomically shaped, nonskid 2-component handle
- Delivered with one 20 V Li-Ion battery pack (2.0 Ah) incl. 30 min. quick charger

■ **APP-5620**

**Power Push Cordless Caulking Gun 20 V
for 310 ml cartridges and sachets up to 600 ml**



- long 600 ml clear barrel for sausage packs
- Incredibly high squeezing pressure of 4700 N for a simple processing of highly viscous material
- Up-to-date lithium-ion battery technology for maximum performance at a minimum weight (power tool including battery 2.46 kg)
- highest application accuracy of all battery guns on the market
- Variable speed trigger for optimal control
- Vmax restriction on 6-speed wheel (feed rate 0 - 9 mm/s)
- Remaining content easily visible by the position of the rack
- No dripping of sealant thanks to electronic rack release function after disengaging the trigger
- Rack disengages automatically for fast reloading
- Ergonomically shaped, nonskid 2-component handle
- Delivered with one 20 V Li-Ion battery pack (2.0 Ah) incl. 30 min. quick charger

■ **APP-5420-URS**

Conversion Kit 600 ml for APP-5420



With this conversion kit you can convert your Power Push caulking gun APP-5420 without effort into a caulking gun with 600 ml clear barrel.

The converted caulking gun is equal to our item number APP-5620. The kit includes all necessary parts and the tool can be rebuilt at any time.

■ **APP-5420-TZ**

Clear barrel 400 ml for APP-5420





■ **APP-5420-LG** Power Push Quick Charger 20 V
for APP-5420 / APP-5620



■ **APP-5420-BA** Power Push Adapter for sachets
for APP-5420 / APP-5620



■ **BP-5420** Power Push Li-Ion Battery 20 V (2.0 Ah)
for APP-5420 / APP-5620

■ **PCG-180-KF Milwaukee Cordless Caulking Gun 18 V for 310 ml cartridges and sachets up to 400 ml**



- ProGlass exclusive remodeling with 400 ml aluminium barrel
- high squeezing pressure of 4300 N for a simple processing of highly viscous material
- up-to-date lithium-ion battery technology for maximum performance at a minimum weight (power tool including battery 2.7 kg)
- variable speed trigger for optimal control
- Vmax restriction on 6-speed wheel (feed rate 0 - 9 mm/s)
- remaining content easily visible by the position of the rack
- no dripping of sealant thanks to electronic rack release function after disengaging the trigger
- rack disengages automatically for fast reloading
- ergonomically shaped, non-skid 2-component handle
- delivered with one 18 V Li-Ion battery pack (1.5 Ah)
- Milwaukee 30-min. quick charger included

■ **PCG-180-KFT Milwaukee Cordless Caulking Gun 18 V for 310 ml cartridges and sachets up to 400 ml with clear barrel**



- high squeezing pressure of 4300 N for a simple processing of highly viscous material
- Up-to-date lithium-ion battery technology for maximum performance at a minimum weight (power tool including battery 2.7 kg)
- highest application accuracy of all battery guns on the market
- Variable speed trigger for optimal control
- Vmax restriction on 6-speed wheel (feed rate 0 - 9 mm/s)
- Remaining content easily visible due to the transparent barrel
- No dripping of sealant thanks to electronic rack release function after disengaging the trigger
- Rack disengages automatically for fast reloading
- Ergonomically shaped, nonskid 2-component handle
- Delivered with one 18 V Li-Ion battery pack (1,5 Ah)
- Milwaukee 30-Min. quick charger included

■ **PCG-180**



Milwaukee Cordless Caulking Gun 18 V for 310 ml cartridges

- one-side open plastic barrel for quick and easy reloading of cartridges
- high squeezing pressure of 4300 N for a simple processing of highly viscous material
- up-to-date lithium-ion battery technology for maximum performance at a minimum weight (power tool including battery 2.6 kg)
- variable speed trigger for optimal control
- Vmax restriction on 6-speed wheel (feed rate 0 - 9 mm/s)
- remaining content easily visible by the position of the rack
- no dripping of sealant thanks to electronic rack release function after disengaging the trigger
- rack disengages automatically for fast reloading
- ergonomically shaped, non-skid 2-component handle
- delivered with one 18 V Li-Ion battery pack (1.5 Ah)
- Milwaukee 30-min. quick charger included

■ **PCG-180-F**



Milwaukee Cordless Caulking Gun 18 V for 310 ml cartridges and sachets up to 600 ml

- long 600 ml aluminium barrel for big sachets
- high squeezing pressure of 4300 N for a simple processing of highly viscous material
- up-to-date lithium-ion battery technology for maximum performance at a minimum weight (power tool including battery 2.9 kg)
- variable speed trigger for optimal control
- Vmax restriction on 6-speed wheel (feed rate 0 - 9 mm/s)
- remaining content easily visible by the position of the rack
- no dripping of sealant thanks to electronic rack release function after disengaging the trigger
- rack disengages automatically for fast reloading
- ergonomically shaped, non-skid 2-component handle
- delivered with one 18 V Li-Ion battery pack (1.5 Ah)
- Milwaukee 30-min. quick charger included



■ **BP-180**

**Milwaukee Li-Ion Battery 18 V (1.5 Ah)
for PCG-180 /-F /-KF /-KFT**



■ **PBA-1827**

**Milwaukee Quick Charger (30 min.)
for PCG-180 /-F /-KF /-KFT**



■ **PCG-180-URS Conversion Kit for Milwaukee 600 ml (PCG-180-F)**

With this conversion kit you can convert your Milwaukee caulking gun PCG-180 or PCG-180-KF / KFT without effort into a caulking gun with 600 ml aluminium barrel. The converted caulking gun is equal to our item number PCG-600-F. The kit includes all necessary parts and the tool can be rebuilt at any time.

■ **AKP-420**



Cox Cordless Caulking Gun Easipower Plus 10.8 V for cartridges and sachets up to 400 ml

- short 400 ml aluminium barrel for cartridge and sachet use
- powerful caulking gun with an ejection pressure of 2500 N
- Variable speed trigger for controlled application
- Vmax restriction with control dial
- Remaining content easily visible by the position of the rack
- Soft touch grip and rubber pads to protect the tool
- No dripping of sealant thanks to electronic rack release function after disengaging the trigger
- Weight (power tool incl. battery): 1.7 kg
- Delivered with one 10.8 V, 1.5 Ah Li-Ion battery pack
- Cox 30-Min. quick charger included

■ **AKP-620**



Cox Cordless Caulking Gun Easipower Plus 10.8 V for cartridges and sachets up to 600 ml

- long 600 ml aluminium barrel for cartridge and sachet use
- powerful caulking gun with an ejection pressure of 2500 N
- Variable speed trigger for controlled application
- Vmax restriction with control dial
- Remaining content easily visible by the position of the rack
- Soft touch grip and rubber pads to protect the tool
- No dripping of sealant thanks to electronic rack release function after disengaging the trigger
- Weight (power tool incl. battery): 1.86 kg
- Delivered with one 10.8 V, 1.5 Ah Li-Ion battery pack
- Cox 30-Min. quick charger included



- **BP-410P** Li-Ion Battery Pack 10.8 V, 1.5 Ah for AKP-420 / AKP-620



- **AKP-410-LG** Cox Battery Quick Charger 10.8 V for AKP-410/-610 and AKP-420/-620



- **AKP-075/L-01** Aluminium front cap for battery caulking guns
The robust front cap is made of die casted aluminium and can be used for most caulking guns from COX, Metabo, Milwaukee and Panasonic.



- **TM-TN-0022** Plastic front cap for caulking guns
The robust front cap is made of plastic and can be used for most caulking guns from COX, Metabo, Milwaukee and Panasonic.

■ **AKP-472**



Cordless Caulking Gun 7.2 V

- short 400 ml aluminium barrel for cartridge and sachet use
- powerful caulking gun with an ejection pressure of 4500 N
- Variable speed trigger for controlled application
- Vmax restriction with control dial
- Remaining content easily visible by the position of the rack
- No dripping of sealant thanks to electronic rack release function after disengaging the trigger
- Weight (power tool incl. battery): 1290 g
- Delivered with one 7.2 V, 1.5 Ah Li-Ion battery pack
- 90-Min. charger included

■ **BP-472**

Li-Ion Battery Pack 7.2 V (1.5 Ah) for AKP-472

Alternative rechargeable batteries for Milwaukee caulking guns

■ **BP-180-Z**

Rechargeable Li-Ion Battery Pack 18 V (2.0 Ah) for PCG-180 /-F /-KF /-KFT



- Type: Li-Ion
- Voltage: 18V
- Demand: 2000mAh / 36Wh
- Weight: 356 g

■ **BP-180-ZHP**

Rechargeable Li-Ion Battery Pack High Power 18 V (4.0 Ah) for PCG-180 /-F /-KF /-KFT & ANT-M18



- Type: Li-Ion
- Voltage: 18V
- Demand: 4000mAh / 72Wh
- Weight: 596 g



■ **TN-310**

**COX Pneumatic Caulking Gun for 310 ml cartridges
max. operating pressure 10 bar**

- pneumatic caulking gun without piston - compressed air streams directly towards the bottom of the cartridge (the cartridge must not be damaged or dented at the bottom)
- **NOT** suitable for sachets!
- regulation of ejection speed with integrated valve



■ **TN-600**

**COX Pneumatic Caulking Gun for 600 ml sachets
max. operating pressure 10 bar**

- pneumatic caulking gun with floating piston - compressed air streams directly towards the bottom of the floating piston which presses towards the sachet
- **NOT** suitable for cartridges!
- regulation of ejection speed with integrated valve



■ **TM-600**

**COX Pneumatic Caulking Gun for cartridges and sachets from
310ml up to 600ml**

- Features of the compact Pneumatic Caulking Gun
- Very handy because of a perfect length and a ergonomic handle
 - This gun is usable for cartridge 290-310ml even for sachet from 300-600ml
 - Easy change from cartridge to sachet converting into 10 sec because of a special quick release system.



■ CT-318

COX Manual Caulking Gun 18:1 for 310 ml cartridges

- the trigger ratio 18:1 facilitates ejection of high viscosity sealants compared to standard caulking guns
- solid construction
- approved long-living mechanism



■ AV-418

COX Manual Caulking Gun 18:1 for cartridges and sachets up to 400 ml

- the trigger ratio 18:1 facilitates ejection of high viscosity sealants compared to standard caulking guns
- solid construction
- approved long-living mechanism



■ AC-325

COX Manual Caulking Gun 26:1 for 310 ml cartridges

- the trigger ratio 26:1 enables to eject even high viscosity auto glass sealants
- heavy construction for long durability
- the established mechanism is equipped with a wear compensating device. That means, even after longer use, no clearance at the trigger



■ AC-625C

COX Manual Caulking Gun 26:1 for cartridges and sachets up to 600 ml

- the trigger ratio 26:1 enables to eject even high viscosity auto glass sealants
- heavy construction for long durability
- the established mechanism is equipped with a wear compensating device. That means, even after longer use, no clearance at the trigger



■ AV-435

**COX Manual Caulking Gun 35:1
for cartridges and sachets up to 400 ml**

- the handy gun enables over the perfect trigger ratio to eject even high viscosity glass sealants
- the trigger ratio 35:1 facilitates ejection of high viscosity sealants compared to standard caulking guns
- solid construction
- approved long-living mechanism



■ 2P1021

Plastic Adaptor for sachets

This plastic adaptor is part of every COX caulking gun for sachets and also parts of some battery powered caulking gun for sachets. Whenever a sachet was clamped in your gun you should replace this adaptor.



■ ASB-001

Adaptor Kit for Sachets

Sachet clamped? Or even ripped? We know the problem! And here is the solution: An adaptor that properly fits the cylinder of your gun. That does not clamp the sachet. And that empties the sachet economically. Suitable for following products from our range: AKP-050, AKP-050L, AV-418, AV-618, PCG-180-KF, TM-400, and many others on the market!

■ **AGR-1105**

**Rubber Spacers Round (Ø 11 mm, height 5 mm)
mat with 55 pieces**

These self-adhesive round rubber spacers are equal with the ones used by BMW. But of course you can use them also on all other vehicles as a universal spacer.



Ø 11 mm

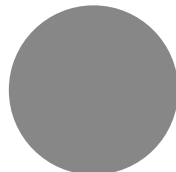

■ **AGT-1105**

**Rubber Spacers round, clear (Ø 11 mm, height 5 mm)
Pad with 55 pieces**

These self-adhesive round transparent rubber spacers are equal with the ones used by Opel. But of course you can use them also on all other vehicles as a universal spacer.



5 mm



■ **AGQ-1265**

**Rubber Spacers, square, black (12.6 x 12.6 mm, height 5.7 mm)
Pad with 50 pieces**

These self-adhesive quadrate rubber spacers are equal with the ones used by Mini Countryman R60. But of course you can use them also on all other vehicles as a universal spacer.

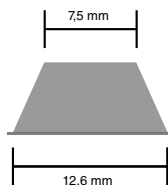

■ **AGV-0906**

**Rubber Spacers Rectangular (LxWxH: 30 x 9 x 6 mm)
package at 100 pieces**

Self-adhesive rectangular rubber spacers. You can cut them according to your needs. They are a practically irreplaceable utility when installing windscreens.

Thanks to the self-adhesive underside you can put them wherever you want.

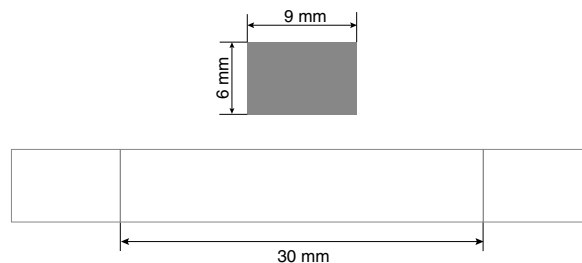
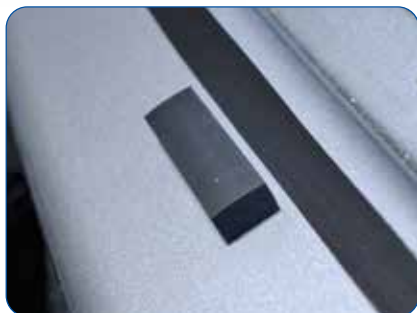

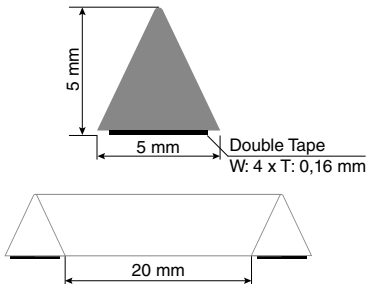

■ **AGD-0505**

Rubber Spacers triangular (LxWxH: 20 x 5 x 5 mm), bag with 100 pieces

Self-adhesive triangle rubber spacers. You can cut them according to your needs. They are a practically irreplaceable utility when installing windscreens. Thanks to the self-adhesive underside you can put them wherever you want.

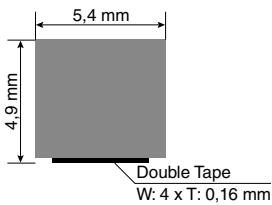
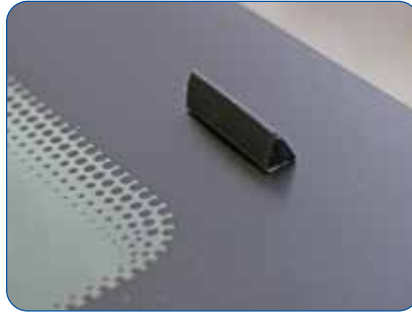

■ **AGV-5449**

Rubber Spacers rectangular (25 x 5,4 x 4,9 mm), bag with 100 pieces

Self-adhesive rectangular rubber spacers. You can cut them according to your needs. They are a practically irreplaceable utility when installing windscreens. Thanks to the self-adhesive underside you can put them wherever you want.



■ **KB-1228**

**Rubber Spacers rectangular (LxWxH: 25 x 12 x 10 mm)
bag with 50 pieces**

Rectangular rubber spacers.(no self-adhesive). You can cut them according to your needs. They are a practically irreplaceable utility when installing windscreens.

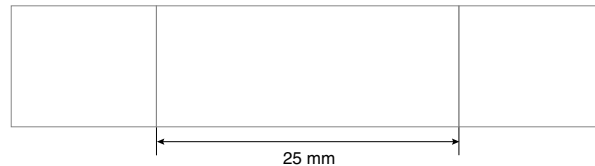
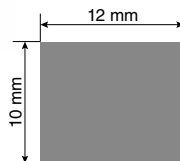

■ **AKV-2515**

**Spacer pads, rectangular,
package at 8 pieces**

- dimensions (LxWxH): 25 x 15 x 5.4* mm
- reclosable fastener with self-adhesive backside

*height for double sided use

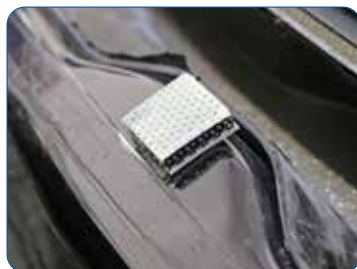

■ **TO-1437**

Pinchweld Cleaning Brushes package at 10 pieces

■ **TO-1437-100**

Pinchweld Cleaning Brushes package at 100 pieces



A clean pinchweld is the base for a properly installed and leak-proof windscreen. But it is not always necessary to use a vacuum cleaner. Many times a brush will be sufficient to clean the pinchweld before cutting down the old polyurethane. The brushes are made of horsehair that is soft to the paint but strong enough to brush away the dirt.

■ **KFB-230**

Pinchweld Cleaning Brush, package at 2 pieces



The solid brush made of galvanized steel with nylon bristles is well suitable for the removal of tenacious stain from the pinchweld. Also for the mobile service, wehn no vacuum cleaner is available, this brush does a good job.

■ **KFP-050**

Pinchweld Cleaning Brush



A clean pinchweld is the base for a properly installed and leak-proof windscreen. But it is not always necessary to use a vacuum cleaner. Many times a brush will be sufficient to clean the pinchweld before cutting down the old polyurethane. The brush are made of synthetic hair that is soft to the paint but strong enough to brush away the dirt.



■ **PRS-118**

ProGlass Rust Remove Pencil

A practical pen to quickly and tidily erase small corroded points. The „core“ of the pen consists of a 3 cm long bundle of fibre glass with a very good abrasive effect. Delivery with two additional bundles of fibre glass, stored inside the shaft, for replacement.



■ **DM-1094**

Applicators small, lint-free, 150 mm long, 100 pieces per plastic bag

Small head applicators with a wooden stick.



■ **APM-100-B**

Mini-Applicators, lint-free, 125 mm long, 100 pieces per plastic bag

These applicators with a smaller diameter should be used on all vehicles with a very narrow pinchweld. The small head facilitates a clean application without primer being visible after the installation.





■ **AP-100**

Applicators, lint-free, 105 mm long, 100 pieces per carton

■ **AP-100-B**

Applicators, lint-free, 105 mm long, 100 pieces per plastic bag

■ **AP-25**

Applicators, lint-free, 105 mm long, 25 pieces per plastic bag

■ **AP-2500**

Applicators, lint-free, 105 mm long, 2.500 pieces in a corrugated cardboard box (not shown)

Applicators for clean and exact application of black and transparent primers, cleaning agents, etc.

The applicator tufts are made of pure cotton, virtually lint-free, solid and tightly equipped, for an evenly covering application.

Ø ca. 22 mm



ca. 105 mm

■ **APL-100**

Applicators, lint-free, 130 mm long, 100 pieces per carton

■ **APL-100-B**

Applicators, lint-free, 130 mm long, 100 pieces per plastic bag

■ **APL-25**

Applicators, lint-free, 130 mm long, 25 pieces per plastic bag

■ **APL-2500**

Applicators, lint-free, 130 mm long, 2.500 pieces in a corrugated cardboard box (not shown)

The 130 mm applicators keep your fingers clean.

With the longer wire they also reach the bottom of most 250 ml bottles. All other features of the APL applicators are the same than of our AP applicators.

Ø ca. 22 mm

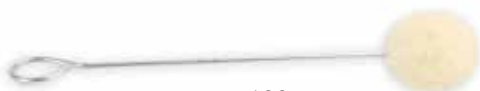

ca. 130 mm

■ PML-145-1

ProGlass Installation Suction Lifter

The installation suction lifter makes it possible to align a freshly installed glass with millimetre precision and to fix it securely until the save drive-away time is obtained.



- Precise alignment of the glass by simply twisting the handle
- Two bell-shaped rubber pads with large seal for easier handling and additional safety against coming off
- Pin-jointed heads bridge angles of max. 30°
- Load capacity for each lifter is 60 kg
- Heads made of shock-resistant plastic, handle made of powder-coated aluminium
- Diameter of suction cups 150 mm

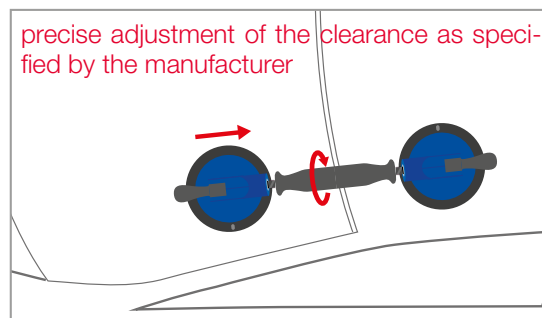
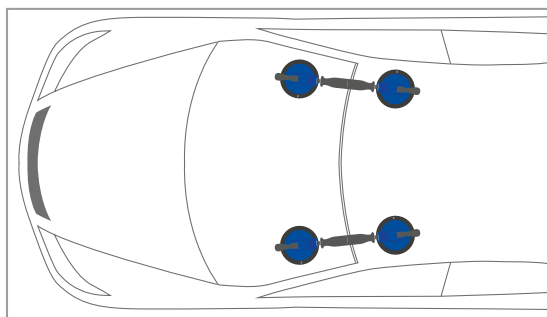

■ FDS-700

Flexible Double Suction Cup

The flexible double suction cup is the best to secure a freshly bonded windscreen. These suction cups stay exactly in position and will not let the glass move a single millimeter! Made of two plastic suction heads with 115 mm rubber disks, connected with a foam covered steel cable (cable length 42 cm).



■ **ML-101**

Assembly Jig 10 x 1.0 mm package at 2 pieces

For a professional windscreen installation in accordance with the manufacturer's instructions you must observe the correct clearance between the glass and the car body. As bonded glasses must not be moved once they have been set, it is beneficial to ensure the correct clearance during the installation process.

With its 1.0 mm thick plastic discs the assembly jig permits an auto glass installation accurate to the last millimetre. Simply position as many discs as needed between glass and pinchweld. The assembly jig can be fixed either on the glass or on the car body.

At the same time the assembly jig can be used as a clearance gauge for all car body jobs (e. g. when mounting fenders or aligning doors and hoods).



■ **SSH-290**

Pinchweld Cleaning Brush

Holds the side window while you are working on the window lifter so that you have both hands free. This window holder set also keeps a windscreen from sliding down while the polyurethane hardens (fix one end on the glass, the other end on top of the car).

Improved version: More stability, due to the cast-in thread. Cable length 45 cm





■ KS-125

Body Filler Applicator Set, in 3 parts

A perfect means to trim and correct fresh PU beads after setting a new glass or to fill up gaps. Remaining adhesive can easily be pulled of the plastic after it is cured.



■ ABS-025

ProGlass Airbag Stickers package of 25 pieces

Almost every car manufacturer has an own airbag warning sticker for the windscreen. Our stickers help you to save time and money to purchase different stickers from the manufacturers. Our multi-useable airbag sticker is made of transparent adhesive foil and can be used for all passenger cars with driver airbag, passenger airbag and side-impact airbag.





OCTOPUS

ProGlass OCTOPUS Multi-brand calibration device for driver assistance systems

- high-precision mechanical calibration device
- Optimal measurement accuracy according to the highest OEM specifications
- Fast and exact alignment using point and line lasers
- Maximum efficiency thanks to the patented swivel arm system
- combined device for cars and trucks (optional extension)
- Targets / calibration boards available for many brands (optional accessories)
- Optimized for use with TEXA diagnostic software IDC5 CAR / TRUCK (including assignment as an accessory KIT – we are official TEXA sales partner)
- Compatible with existing diagnostic devices from other manufacturers *
- Compatible with existing boards from other manufacturers *
- Calibration of front radar systems on cars and trucks, incl. lidar / laser scanner (optional extension)

* For further information, please contact our customer service or your local sales force.

■ OCC-300P



OCTOPUS Car Pro
Multi-Brand Calibration device for advanced driver assistance systems

Device for calibrating the front camera / multifunction camera on cars and vans.

The PRO version already contains the wheel mounts with rotating mirror scales and the adjustment bar with laser scales. This enables calibration via the geometric travel axis, in accordance with the manufacturer's specifications of the VW group brands.

Scope of delivery:

- OCTOPUS PRO trolley with adjustment bar and laser scales
- 2 wheel mounts with mirror scales
- Cross line laser
- Accessory case
- Central holder
- Swivel arm
- Target holder for cars / transporters
- Double target VAG / Mazda / Mercedes (item OCC-DT01)
- Single target FCA / PSA / Opel / Kia / Hyundai (item OCC-ST01)
- Operating and assembly instructions

■ OCC-300B



OCTOPUS Car Basic
Multi-Brand Calibration device for advanced driver assistance systems

Device for calibrating the front camera / multifunction camera on cars and vans.

With the BASIC version, the calibration is carried out with the included cross line laser via the vehicle's symmetry axis. The system thus meets the requirements of most vehicle manufacturers

Scope of delivery:

- OCTOPUS BASIC trolley
- Cross line laser
- Central holder
- Swivel arm
- Target holder for cars / transporters
- Double target VAG / Mazda / Mercedes (item OCC-DT01)
- Single target FCA / PSA / Opel / Kia / Hyundai (item OCC-ST01)
- Operating and assembly instructions

■ **OCT-400P**



OCTOPUS PRO TRUCK
Multi-Brand Calibration device for advanced driver assistance systems

Device for calibrating the front camera / multifunction camera on trucks.

The PRO version already contains the wheel mounts with rotating mirror scales and the adjustment bar with laser scales. This enables calibration via the geometric travel axis, in accordance with the MAN manufacturer's specifications.

Scope of delivery:

- OCTOPUS PRO trolley with adjustment bar and laser scales
- 2 wheel mounts with mirror scales
- Cross line laser
- Accessory case
- Central holder
- Swivel arm
- Target holder for trucks
- Single target MAN / Scania / Iveco (item OCT-ST01)
- Single target Volvo / Renault (item OCT-ST02)
- Operating and assembly instructions

■ **OCT-400B**



OCTOPUS Truck Basic
Multi-Brand Calibration device for advanced driver assistance systems

Device for calibrating the front camera / multifunction camera on trucks.

With the BASIC version, the calibration is carried out with the included cross line laser via the vehicle's symmetry axis. The system thus meets the requirements of most vehicle manufacturers.

Scope of delivery:

- OCTOPUS BASIC trolley
- Cross line laser
- Central holder
- Swivel arm
- Target holder for trucks
- Single target MAN / Scania / Iveco (item OCT-ST01)
- Single target Volvo / Renault (item OCT-ST02)
- Operating and assembly instructions

■ **OCT-3040G** Upgrade kit geometric travel axis for OCTOPUS Car & Truck

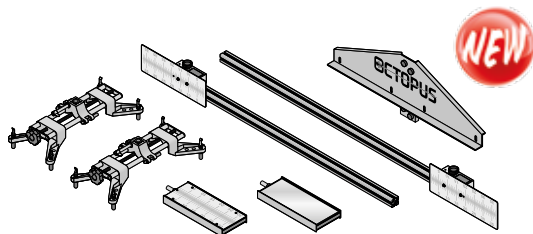

The set contains the wheel mounts with rotating mirror scales and the adjustment bar with laser scales, including the necessary accessories. In this way, an OCTOPUS Basic is upgraded to an OCTOPUS Pro.

■ **OCC-300-E** Extension kit for trucks (from OCTOPUS Car to Truck), including MAN / Scania and Volvo / Renault targets

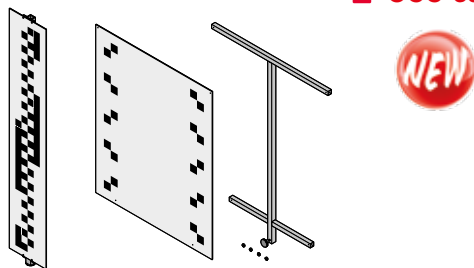

The set contains all the parts required to expand an OCTOPUS car into an OCTOPUS truck. This allows the device for cars to be used very easily for calibrating cars and trucks.

■ **OCT-400-E** Extension kit transporter / car (from OCTOPUS truck to car)

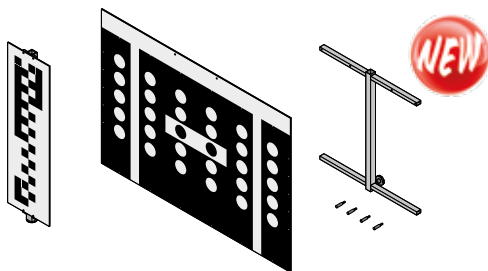

The set contains all the parts required to expand an OCTOPUS truck into an OCTOPUS car. This means that the device for trucks can be used very easily for the calibration of trucks and cars.

■ **OCC-RSS** OCTOPUS Tyre Clamp Set for installing the wheel mounts using plastic centring pins and tyre claws



The addition of the tyre clamp set to the OCTOPUS wheel mounts enables safe and damage-free mounting of the wheel mounts on very sensitive aluminium rims. The original stainless steel positioning pins are replaced by aluminium pins with plastic caps. (2 different versions). The plastic centring pins are supplemented by adjustable tyre claws that securely clamp the wheel mount onto the wheel.

■ **OCC-200E**



ProGlass OCTOPUS Car ECO
Multi-brand calibration device for driver assistance systems

Including targets Renault/Smart und FCA/PSA/Opel/Kia/Hyundai.

Scope of delivery:

- precise mechanical calibration device for front camera calibration
- Calibration based on the vehicle symmetry axis in accordance with the specifications of most vehicle manufacturers
- Fast and precise alignment using line laser and laser receiver
- Targets / calibration boards available for many brands (optional accessories)
- Compatible with existing boards from other manufacturers*
- Easily transportable solution - very suitable for mobile use
- Quick assembly and space-saving storage thanks to the foldable chassis

* For further information, please contact our customer service or your local sales force.

OCTOPUS *ECO*



■ **OCC-SLR**

OCTOPUS Laser swivel device with angle adjustment and foldable mirror

Laser swivel device with angle adjustment and foldable mirror for easy alignment of the line laser (accessory item for the OCTOPUS Car ECO)



■ OCC-DT01

**Double target
VAG / Mazda / Mercedes for OCTOPUS Car**

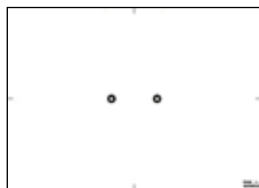
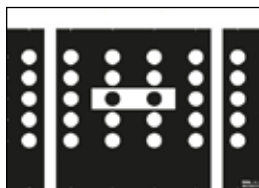

Double target VAG / Mazda / Mercedes for OCTOPUS Car

This accessory was designed for use with an OCTOPUS calibration device. Any other use represents improper use and is expressly at your own risk!

■ OCC-DT02

**Double target
Nissan / Alfa Romeo for OCTOPUS Car**

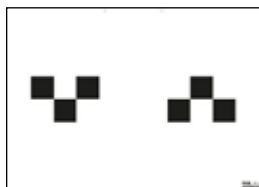

Double target VAG / Mazda / Mercedes for OCTOPUS Car

This accessory was designed for use with an OCTOPUS calibration device. Any other use represents improper use and is expressly at your own risk!

■ OCC-DT03

**Double target
Subaru / Hyundai for OCTOPUS Car**

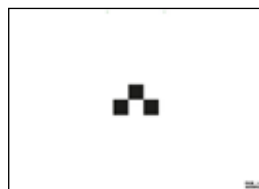
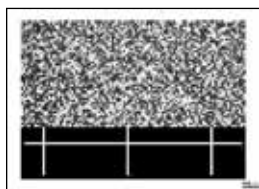

Double target Subaru / Hyundai for OCTOPUS Car

This accessory was designed for use with an OCTOPUS calibration device. Any other use represents improper use and is expressly at your own risk!

■ OCC-DT04

**Double target
Honda / Mazda for OCTOPUS Car (in 2 parts)**

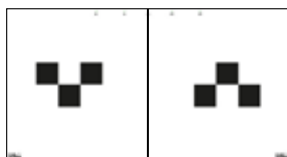

Double target Honda / Mazda for OCTOPUS Car (in 2 parts)

This accessory was designed for use with an OCTOPUS calibration device. Any other use represents improper use and is expressly at your own risk!

■ **OCC-DT05**

**Double target
Toyota / Lexus for OCTOPUS Car**

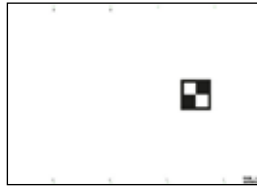
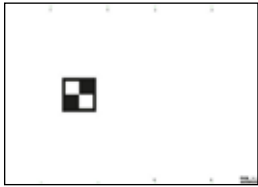

Double target Toyota / Lexus for OCTOPUS Car

This accessory was designed for use with an OCTOPUS calibration device. Any other use represents improper use and is expressly at your own risk!

■ **OCC-DT06**

**Double target
Toyota / Lexus / Mitsubishi / Suzuki for OCTOPUS Car**

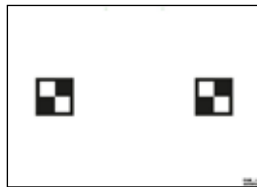
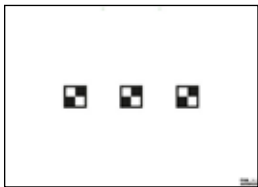

Double target Toyota / Lexus / Mitsubishi / Suzuki for OCTOPUS Car

This accessory was designed for use with an OCTOPUS calibration device. Any other use represents improper use and is expressly at your own risk!

■ **OCC-DT07**

**Double target
Suzuki / Nissan for OCTOPUS Car**

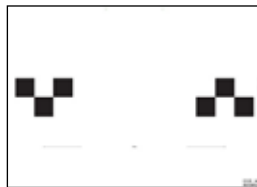
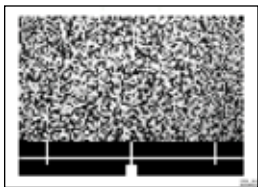

Double target Suzuki / Nissan for OCTOPUS Car

This accessory was designed for use with an OCTOPUS calibration device. Any other use represents improper use and is expressly at your own risk!

■ **OCC-ET01**

**Double target
FCA / PSA / Opel / Kia / Hyundai / Renault / Smart
for OCTOPUS Car ECO**

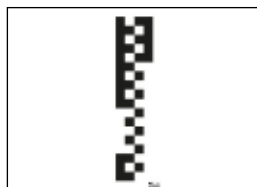
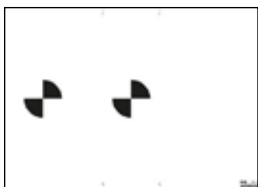

Double target FCA / PSA / Opel / Kia / Hyundai / Renault / Smart for OCTOPUS Car ECO

This accessory was designed for use with an OCTOPUS calibration device. Any other use represents improper use and is expressly at your own risk!



■ **OCC-ST01**

Single target
FCA / PSA / Opel / Kia / Hyundai for OCTOPUS Car

Single target FCA / PSA / Opel / Kia / Hyundai for OCTOPUS Car

This accessory was designed for use with an OCTOPUS calibration device. Any other use represents improper use and is expressly at your own risk!

■ **OCC-ST02**

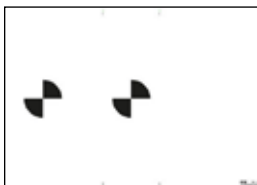

Single target
Renault / Smart for OCTOPUS Car

Single target Renault / Smart for OCTOPUS Car

This accessory was designed for use with an OCTOPUS calibration device. Any other use represents improper use and is expressly at your own risk!

■ **OCC-ST03**

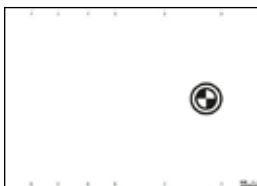

Single target
Honda for OCTOPUS Car

Single target Honda for OCTOPUS Car

This accessory was designed for use with an OCTOPUS calibration device. Any other use represents improper use and is expressly at your own risk!

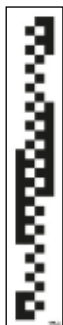

■ **OCT-ST01**

Single target
MAN / Scania for OCTOPUS Truck

Single target MAN / Scania for OCTOPUS Truck

This accessory was designed for use with an OCTOPUS calibration device. Any other use represents improper use and is expressly at your own risk!

■ **OCT-ST02**

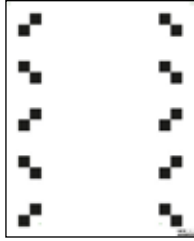

**Single target
Volvo / Renault for OCTOPUS Truck**

Single target Volvo / Renault for OCTOPUS Truck

This accessory was designed for use with an OCTOPUS calibration device. Any other use represents improper use and is expressly at your own risk!

■ **OCC-KLL**



Cross line laser

Cross line laser with pulse mode, Precision of measure +/-2 mm -10m, Laser color red, Wave length 600-690 nM, Laser class II (2) , Laser range angle V130° - H150°, Certifications CE, RoHS, FDA, Class II, IEC60825-1:2014, IP 54, Pendulum angle max. +/- 4°

■ **LEM-400**



Laser Distance Meter

Laser distance meter with high precision ±2mm for support calibration and other measuring process. Small and handy device with good over-view and easy handling.

■ **DNM-3050**



Digital Inclinometer

Digital Inclinometer to adjust or test the relative angle between surfaces.

■ TX-APP06.5-OB



TEXA diagnostic software IDC5 Plus Car with interface Navigator TXT Multihub + 12 month updates and support

TEXA's IDC5 software is the ideal partner for our OCTOPUS calibration devices. Because just like the OCTOPUS, the IDC5 software can be used for both cars and trucks and covers a huge range of vehicles. Through specific diagnostic aids for each make and model, the diagnostic software provides the necessary information such as the target to be used, the correct height, the distance to the vehicle, etc. for the correct positioning of the calibration device and guides the user step by step through all phases of the adjustment. The diagnostic and calibration protocol can be saved in the customer administration or printed out directly for the customer. Thanks to TEXA Security Access with Authenticated Diagnosis, unlocking the Security Gateways (SGW) on modern vehicles is safe, official and simple - without the tedious and time-consuming registration with each with each individual vehicle manufacturer.

The new TXT Multihub vehicle interface has excellent connectivity and masters all current and future important protocols.

- WiFi module for diagnostic operations under CAN, CAN FD and DoIP
- Network connection (Ethernet) for DoIP (ISO 13400)
- USB connection for all types of diagnostics, incl. pass-thru (SAE J2534-1 and SAE J2534-2)
- Bluetooth interface for conventional diagnostics



■ TX-P12926



TEXA diagnostic software IDC5 Plus Truck (integration) for installation on a PC

Extension of the diagnostic software IDC5 Plus Car by the truck module. Supplied as an electronic licence. Software only available as download.

■ **TX-APP23.1-OB**



TEXA diagnostic device AXONE Nemo 2 incl. software IDC5 Premium car, with interface Navigator TXT Multihub + 12 months updates and support

The AXONE Nemo 2 is the reference in the world of diagnostic display devices. Thanks to its magnesium housing, the workshop tablet with a 12-inch screen is not only particularly light and robust, but also contains excellent hardware and software. Internally equipped with the Windows 10 Enterprise operating system and “powered” with an Intel® Pentium Quad Core N5000 “Gemini Lake” processor with an 8 GB RAM memory and a 250 GB SSD hard drive. Connections are established through an advanced 2-channel Wi-Fi and a Bluetooth® 4.2 module. The Nemo 2 also has 2 photo cameras that can be used to create more detailed customer reports or to send photos for customer service inquiries. In conjunction with the IDC5 software, the AXONE Nemo 2 is a real premium device that is able to solve numerous problems and to fully satisfy you and your customers.

The pre-installed IDC5 Premium Car diagnostic software includes the Supercar module, which is otherwise chargeable. The package also includes the new vehicle interface TXT Multihub (detailed description see art. TX-APP06.5-OB).

■ **TX-P13020**



TEXA diagnostic software IDC5 Premium Truck for installation on the AXONE Nemo 2

Extension of the diagnostic software IDC5 Premium Car by the truck module. Supplied as an electronic licence. Software only available as download.

■ TX-APT06.6-OB



TEXA diagnostic software IDC5 Plus Truck with interface Navigator TXT Multihub + 12 month updates and support

TEXA's IDC5 software is the ideal partner for our OCTOPUS calibration devices. Because just like the OCTOPUS, the IDC5 software can be used for both cars and trucks and covers a huge range of vehicles. Through specific diagnostic aids for each make and model, the diagnostic software provides the necessary information such as the target to be used, the correct height, the distance to the vehicle, etc. for the correct positioning of the calibration device and guides the user step by step through all phases of the adjustment. The diagnostic and calibration protocol can be saved in the customer administration or printed out directly for the customer. Thanks to TEXA Security Access with Authenticated Diagnosis, unlocking the Security Gateways (SGW) on modern vehicles is safe, official and simple - without the tedious and time-consuming registration with each with each individual vehicle manufacturer.

The new TXT Multihub vehicle interface has excellent connectivity and masters all current and future important protocols.

- WiFi module for diagnostic operations under CAN, CAN FD and DoIP
- Network connection (Ethernet) for DoIP (ISO 13400)
- USB connection for all types of diagnostics, incl. pass-thru (SAE J2534-1 and SAE J2534-2)
- Bluetooth interface for conventional diagnostics



■ TX-P1291B



TEXA diagnostic software IDC5 Plus Car (integration) for installation on a PC

Extension of the diagnostic software IDC5 Plus Truck by the Car module. Supplied as an electronic licence. Software only available as download.

■ TX-APT09.1-OBD



TEXA diagnostic device AXONE Nemo 2 incl. software IDC5 Premium Truck, with interface Navigator TXT Multihub + 12 months updates and support

The AXONE Nemo 2 is the reference in the world of diagnostic display devices. Thanks to its magnesium housing, the workshop tablet with a 12-inch screen is not only particularly light and robust, but also contains excellent hardware and software. Internally equipped with the Windows 10 Enterprise operating system and “powered” with an Intel® Pentium Quad Core N5000 “Gemini Lake” processor with an 8 GB RAM memory and a 250 GB SSD hard drive. Connections are established through an advanced 2-channel Wi-Fi and a Bluetooth® 4.2 module. The Nemo 2 also has 2 photo cameras that can be used to create more detailed customer reports or to send photos for customer service inquiries. In conjunction with the IDC5 software, the AXONE Nemo 2 is a real premium device that is able to solve numerous problems and to fully satisfy you and your customers.

The pre-installed IDC5 Premium Car diagnostic software includes the Supercar module, which is otherwise chargeable. The package also includes the new vehicle interface TXT Multihub (detailed description see art. TX-APP06.5-OBD).

■ TX-P13010



TEXA diagnostic software IDC5 Premium Car for installation on the AXONE Nemo 2

Extension of the diagnostic software IDC5 Premium Truck by the Car module. Supplied as an electronic licence. Software only available as download.

■ **GY-027510**



Booster 12V (600A)

The NOMAD POWER PRO 700 is a lithium-based power pack. It combines 3 functions:

- Battery-Supplied jump start (Booster) for 12V vehicle (motorcycle, quad, car ect.)
- independent supply for all current electrical equipment (smartphone, tablet, computer ect.)
- Emergency lamp 2 x USB-Ports 5V, for charging smartphone, tablet, GPS ect.
- 1 x 15V (10A), ideal for camping, to supply a 12V electrical appliance (cool box, fan ect.)

■ **GY-025967**



Charger with inverter technology 12/24V (100A)

The GYSFLASH 101.24 CNT FV is a powerful inverter charger (100 A). It stabilizes the voltage of a 6 V, 12 V and 24 V lead-acid or lithium battery (lithium-ion "standard" + lithium-iron-phosphate) for vehicle diagnostics and provides optimal charging quality for the maintenance of batteries of the latest technology . The practical USB connection also offers the option of personalization and expansion.

- 4 operating modes:
- Charge: for 6, 12 or 24 V Lead or Lithium batteries from 5 to 1200 Ah.
 - Diagnostic: supports up to 100 A for 12 V or 24 V batteries in vehicles in the diagnostic phase, in maintenance workshops.
 - Showroom: provides power compensation when using the electrical accessories of a demonstration vehicle. It also manages the optimal charging of the battery.
 - Tester: Allows you to check the battery voltage, evaluate the starting system (starter + battery) and the condition of the vehicle's alternator.

■ GY-026971



Charger with inverter technology 12V (120A)

The GYSFLASH 121.12 CNT FV is a powerful inverter charger (120 A). It stabilizes the voltage of a 12V lead-acid or lithium battery for vehicle diagnostics and provides optimal charging quality for the maintenance of batteries of the latest technology. The practical USB connection also offers the option of personalization and expansion.

4 operating modes:

- Charging: for 12 V, lead or lithium (LFP) batteries between 5 - 1500 Ah.
- Diagnostics: supports up to 120 A for 12 V batteries in vehicles during the diagnostic phase in maintenance workshops.
- Showroom: provides power compensation when using a demonstration vehicle's electrical accessories. It also controls the battery's optimal charging process.
- Tester: Tester: allows you to check the battery voltage and evaluate the starting system (starter and battery) as well as the condition of the vehicle's alternator.

■ GY-029415



Charger with inverter technology 12V (100A)

The Gysflash 100-12 HF is an inverter-based, stabilized voltage source with 5 main functions:

- Charging of starter batteries with a processor controlled charging curve
- Support of the 12 V on-board network during the diagnostic phase
- Securing the power supply for demonstration vehicles in the showroom
- Supply of the on-board network when the battery is changed to back up memory contents
- Use of the device as a stabilized voltage source with individually programmable voltage and current





■ **SK-1060K**

ProGlass SK-1060K 1-Component PUR Auto Glass Adhesive cartridge at 310 ml

ProGlass SK-1060K is a single-component auto glass adhesive with a short drive-away time which can be used during the whole year.

The adhesive is high-modulous, easy to applicate, it can be used for practically all vehicles and offers a safe drive-away time of only 1 hour with driverside air bag (tested by TÜV).

With these features ProGlass SK-1060K is a true all-in-one product for automotive replacement glazing.

For further information please refer to the technical data sheet.

packaging unit:
carton at 12 pieces incl. plastic nozzle



■ **SK-1060B**

ProGlass SK-1060B 1-Component PUR Auto Glass Adhesive sachet at 400 ml

ProGlass SK-1060B is a single-component auto glass adhesive with a short drive-away time which can be used during the whole year.

The adhesive is high-modulous, easy to applicate, it can be used for practically all vehicles and offers a safe drive-away time of only 1 hour with driverside air bag (tested by TÜV).

With these features ProGlass SK-1060B is a true all-in-one product for automotive replacement glazing.

For further information please refer to the technical data sheet.

packaging unit:
carton at 12 pieces incl. plastic nozzle and adaptor



■ **SP-1010**

**Adhesive Agent / All-in-One Primer
bottle at 125 ml**

■ **SP-0010**

**Adhesive Agent / All-in-One Primer
applicator-stick at 10 ml**



This all-in-one primer (black primer) is the perfect UV protection for our ProGlass PUR adhesive. But as a real universal talent the primer can also be applied on all other surfaces incl. the remaining PUR bead on the pinchweld and coatings on the new glass. No separate activator or transparent primer is necessary.

Additionally this all-in-one primer is an effective anticorrosive so that eventually occurring damages on the pinchweld can be simply covered with this primer (apply 2 layers).

14 days storage life after the first opening of the bottle!

The handy primer-stick is the clean solution for a one-time application. No laborious opening, no additional applicator needed.

For further information please refer to the technical data sheet.

Bottles can be used for 14 days from the first opening!

Primer sticks are single use, i.e. to consume immediately after opening.



■ **VRS-1000**

**ProGlass Pre-Cleaner
can at 1,000 ml**

The pre-cleaner is meant for cleaning and degreasing of a new glass before applying the primer for the adhesive. The highly effective formulation does not only take off any adhesive tape residues and greasy contaminations but also **reliably removes silicone residues and flexibilizers** from foams and plastic foils that are commonly used to protect automotive glasses during transportation.

■ SKS-1060K ProGlass Bonding Kit Cartridge

Kit contains:

- 1 cartridge SK-1060K auto glass adhesive (310 ml)
- 1 applicator-stick SP-0010 All-In-One primer (10 ml)
- 1 plastic nozzle
- 1 product information / application note

■ SKS-1060B ProGlass Bonding Kit Sachet

Kit contains:

- 1 sachet SK-1060B auto glass adhesive (400 ml)
- 1 applicator-stick SP-0010 All-In-One primer (10 ml)
- 1 plastic nozzle and adaptor
- 1 product information / application note

■ KTO-230



Cartridge Heater for 2 cartridges, 230V

Powerful Cartridge Heater for warm-up two 310 ml cartridges. Guarantees an optimum processing of the PU during the cold season. Delivery without cartridges.

- Voltage: 230V
- Demand: up to 60° Degree
- Capacity: 2 x 310ml Cartridge
- Inside Dimension: $\varnothing = 48 \text{ mm}$ L = 220 mm
- Weight: 1475 g

■ MHP-139



Hot Pocket 12V / 230V for cartridge and sausage up to 400 ml

Very spacious hot pocket with a capacity of 40 l perfect for mobile using in the cold season.

- Connection: 12V/230V
- Output: max. 40 degree
- Length: 495 mm
- Wide: 457 mm
- Height: 178 mm
- Material: Fabric
- Color: Red



- **KSP-1580-12** Plastic nozzles, package of 12, M15 x 1.5 x 82 mm
- **KSP-1580-100** Plastic nozzles, package of 100, M15 x 1.5 x 82 mm

Cartridge nozzles made of PE with embossed cutting marks, for 'cut to fit' use. For the application of auto glass adhesives in aluminium cartridges with standard thread M15 x 1.5. With separately available adaptor (item no. KBA-4915) also suitable for sachets.



- **KSP-15104-12** Cartridge Nozzle, M15 x 1,5 x 105 mm, package at 12 pieces
- **KSP-15104-100** Cartridge Nozzle, M15 x 1,5 x 105 mm, package at 100 pieces

- Cartridge nozzles made of PE for 'cut to fit' use
- Without cutting marks including flange
- For the application of auto glass adhesives in aluminium cartridges with standard thread M15 x 1.5



- **KSP-1580S-12** Plastic nozzles, M15 x 1.5 (pre-cut), package of 12
- **KSP-1580S-100** Plastic nozzles, M15 x 1.5 (pre-cut), package of 100

Cartridge nozzles made of PE with pre-cut V-notch and guiding pin. For the application of auto glass adhesives in aluminium cartridges with standard thread M15 x 1.5. With separately available adaptor (item no. KBA-4915) also suitable for sachets.



- **KBA-4915-12** Adaptor for plastic nozzles M15 x 1.5, package of 12
- **KBA-4915-50** Adaptor for plastic nozzles M15 x 1.5, package of 50

Plastic adaptor made of PE for using auto glass adhesive in sachets with standard plastic nozzles with inside thread M15 x 1.5 mm.



■ **KSP-15105V-10** Cartridge Nozzle M15 x 1,5 x 105 mm,
Package of 10 pieces



- Cartridge nozzles made of PE for 'cut to fit' use
- With cap against drying-out the material
- Without cutting marks including flange
- For the application adhesives in aluminium/plastic cartridges with standard thread M15 x 1.5



■ **KSP-15110D-10** Cartridge Nozzle 360° rotatable, M15 x 1,5, 'cut to fit' model,
Package of 10 pieces

Cartridge nozzles 360° rotatable made of PE for 'cut to fit' use. For the application of auto glass adhesives in aluminium cartridges with standard thread M15 x 1.5. With separately available adaptor (ProGlass KBA-4915) also suitable for sachets.



■ **KA-539** Cartridge Opener

A handy tool to remove the bottom seal (left side in the figure) of many aluminium cartridges as well as to open the front seal (right side in the figure) without making a mess.



■ **UTO-539** Cartridge Opener 2-fold
for regular and wide nozzle openings

A handy tool to remove the bottom seal (left side in the figure) of many aluminium cartridges as well as to open the front seal (right side in the figure) without making a mess. The stem for the nozzle opening is stepped so that you can use it to open both common types of cartridges.



■ **KSZ-163**



Nozzle Cutting Pliers, made of plastic

For easy and tidy cutting a perfect V-notch for sealant application. Pliers made of fiber-reinforced plastic, blade made of aluminium with a millimeter scale.

These pliers cut a narrow and high V-notch which makes them perfect for the application of high-modulus adhesive material.

depth of cut (at a width of 7 mm): 22 mm



■ **KSZ-306**



Nozzle Cutting Pliers, metal version

Robust pliers for easy and tidy cutting a perfect V-notch for sealant application. Pliers made of metal, blade made of solid steel.

These pliers cut a classical wide V-notch. To apply a higher adhesive bead the nozzle opening must be cut to a bigger diameter.

depth of cut (at a width of 7 mm): 13 mm



■ **RKS-594**



Nozzle Cutter

To open plastic cartridges and to cut the nozzle without risk of injury.

■ **MK-081**

Replacement Blades for RKS-594

Package at 5 pieces



■ KSK-050

2C adhesive with 50ml cartridge

2C adhesive long term bonding for the most plastic parts. Fast repair or installation off the following materials: EPDM, PP, PUR, RIM, RRIM, SMC, TPO, TPE und Fibreglas. 2C cartridge with 50 ml adhesive.

- 50 ml 2C
- 30-50 second processing time
- Hand-tight after 90 seconds
- Can be sanded after 5 min.
- Paintable after 30 min.



■ MD-085

Static Mixer (single-use) for KSK-050, single

■ MD-085-P

Static Mixer (single-use) for KSK-050, package of 10 pieces

- Static disposable mixing nozzle off plastic
- For 50 ml 2K cartridge
- Constant high-grade mixing ratio
- Bayonet fitting
- Nozzle length 65 mm
- Total length 85 mm



■ KTP-502K

Manual Caulking Gun 11:1 for 50 ml 2C cartridges

- The trigger ratio 11:1 facilitates ejection of the 2K material
- For 50 ml 2C cartridge
- Solid construction



■ **GMK-300**



quicklink to the product video



ProGlass Glass/Metal Bonding Kit

- high-tensile and fast-curing special adhesive for glass/metal bondings
- for the permanent bonding of rearview mirror plates made of metal to windcreens
- the 2-component superglue cures hand-tight within 30 seconds
- package content is sufficient for bonding approximately 200 mirror plates
- adhesive cures clear-transparent
- the bonding is resistant against humidity and high variation in temperature
- Note: Not suitable for light-alloy mirror stems (e.g. Ford). Danger of tension cracks!
- package contents: 15 ml adhesive, 15 ml activator

■ **SFP-10**

■ **SFP-100**



Mirror Adhesive Pads, package at 10 pieces

Mirror Adhesive Pads, package at 100 pieces

Mirror adhesive pads of OEM quality for tension-free bonding of interior mirrors (e.g. Ford). The double-sided adhesive pad has a very high tack. Degrease glass and mirror base well, then press on the mirror strongly for a few seconds - ready!

dimensions: 41 x 28 x 1.0 mm



■ **RMS-105**

Loctite Interior Mirror Bonding Kit for tension-free bondings

Bonding kit for durable and tension-free bonding of all types of interior mirrors. Package contains 5 ml glue and 10 nylon squares (tintured with activator).



■ **3319**

Loctite Glass/Metal Bonding Kit

Glas/metal bonding kit for durable bondings of interior mirrors. The package contains 5 g glue and 4 ml activator.



■ **LSS-085**

Conductive Silver Pen, 8.5 g

The conductive silver pen is suitable to metal-coat all smooth surfaces. This is a simple method to produce or repair electrically conductive connections. As this pen can also be used overhead it is especially suitable for the repair of defroster wires on a heated rear window.



■ **LSL-030**

Conductive Silver Paint, 3 g

Conductive paint on silver basis. Suitable to metal-coat almost all surfaces. Applied with a fine paint-brush it can be used e. g. for the repair of defroster wires on a heated rear window.



■ **HP-1002**

Fine Paint-Brush

Paint-brush in size 2 (= very fine tip) for the application of conductive silver paint.



■ **TVB-0333**

Fine Line Tape blue, 3 mm wide, reel at 33 m

The fine line tape is made of PVC as a masking tape for different workings. For example it is perfect to paste up a cutting line to facilitate the tailoring of window films. But you can also use it to easily paste up boundary lines when repairing the wires of a rear window heater.



■ **LSK-140**

Conductive Silver Bonding Kit, 14 g

2-component epoxy for making conductive bondings.

This adhesive can be used in all situations where soldering is difficult or impossible. Therefore it is just perfect to re-affix a broken electrical connection to a heated rear window.



■ **TPB-1910**

**Textile Protection Tape black
19 mm wide, reel at 10 m**

■ **TPB-1925**

**Textile Protection Tape black
19 mm wide, reel at 25 m**



The textile protection tape is a multi-purpose adhesive tape. It can be used e.g. to treat creaking linings, plastic parts or cables. It is also very suitable to wrap cable loops.



UP-100B

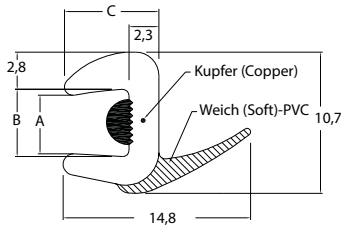

A = 4,5 mm ± 0,3 mm
 B = 5,2 mm ± 0,3 mm
 C = 7,5 mm ± 0,3 mm

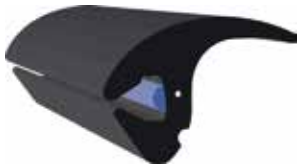

UP-105B

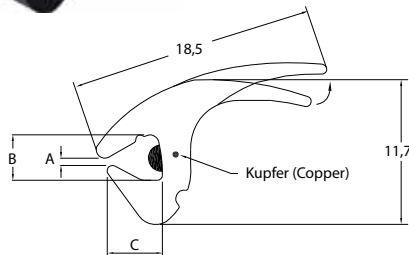

A = 2,5 mm ± 0,3 mm
 B = 3,7 mm ± 0,3 mm
 C = 4,5 mm ± 0,3 mm



UP-107B

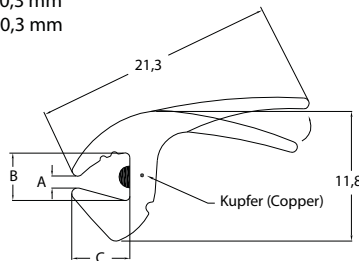

A = 2,5 mm ± 0,3 mm
 B = 4,2 mm ± 0,3 mm
 C = 5,1 mm ± 0,3 mm



UP-200

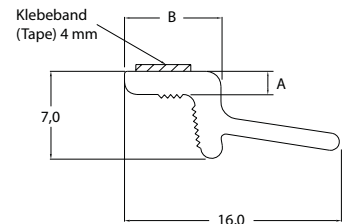

A = 1,7 mm ± 0,3 mm
 B = 7,1 mm ± 0,3 mm

■ **UP-100B**

Universal-Moulding with Butyl Glue
 Type 'T4', reel at 23 m

■ **UP-105B**

Universal-Moulding with Butyl Glue
 16 mm wide, reel at 23 m

■ **UP-107B**

Universal-Moulding with Butyl Glue
 19 mm wide, reel at 23 m

■ **UP-200**

Universal Underside Moulding, self-adhesive
 Type 'VW', reel at 30 m

- With the universal mouldings, compared to model type mouldings, you are able to reduce storage space and at the same time, save a lot of money.
- Our universal mouldings are made of high-quality material and are easy to handle.
- Silk-matt surface for a perfect look
- Material particular flexible, for neatly fitting borders
- Mouldings are suitable for all LSG windscreens with a thickness of 4-6 mm
- For easier installation the glass channel has a thin layer of butyl glue (marked blue in the figure)
- Underside moulding UP-200 with strong adhesive tape (marked blue in the figure) for safe fixation on the glass
- The included metal filament (white spot in the figure / not for UP-200) avoids unintentional stretching of the moulding during the installation or shrinking over time



■ **MCA-265**

Standard Moulding Maker

The standard moulding maker enables to mitre universal mouldings.

We recommend to stick the cuts with Loctite 4850 superglue.

Suitable replacement blade: TK-10 or TKS-100



■ **401**

**Loctite 401 Superglue
tube at 3 g in blister pack**

Loctite 401 is especially suitable for bonding rubber, plastic and metal as well as porous materials like polyurethane foam many vehicle mouldings are made of. This cyanoacrylate glue dries within seconds and forms a transparent, hard layer. It is therefore not applicable for flexible bondings.



■ **4850**

**Loctite 4850 Superglue
tube at 5 g in blister pack**

Loctite 4850 stays flexible after drying and is particularly applicable for bonding elastomers and rubbers as well as many types of plastic, metal and porous materials. This cyanoacrylate glue dries within seconds and forms a transparent and flexible bonding.



- **TMB-5555-3** **Sponge Rubber Tape (Neoprene) 5 x 5 mm self-adhesive, 3 reels at 5.5 m**
- **TMB-5555-P** **Sponge Rubber Tape (Neoprene) 5 x 5 mm self-adhesive, 12 reels at 5.5 m**
- **TMB-6655-3** **Sponge Rubber Tape (Neoprene) 6 x 6 mm self-adhesive, 3 reels at 5.5 m**
- **TMB-6655-P** **Sponge Rubber Tape (Neoprene) 6 x 6 mm self-adhesive, 12 reels at 5.5 m**

Sponge Rubber Tapes are mandatory for many Asian cars and work as a spacer between car body and windscreen. At the same time they make a nice view from inside.

The high-quality neoprene sponge has a high density (small pores) and a rich dark colour.

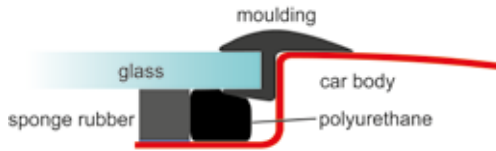

- **TMC-5545-3** **Sponge Rubber Tape (PE) 5 x 5 mm self-adhesive, 3 reels at 4.5 m**
- **TMC-5545-P** **Sponge Rubber Tape (PE) 5 x 5 mm self-adhesive, 12 reels at 4.5 m**
- **TMC-6645-3** **Sponge Rubber Tape (PE) 6 x 6 mm self-adhesive, 3 reels at 4.5 m**
- **TMC-6645-P** **Sponge Rubber Tape (PE) 6 x 6 mm self-adhesive, 12 reels at 4.5 m**

The polyethylene (PE) sponge rubber tapes are used in the same way than the higher grade neoprene tapes.

The difference is the lower density of the PE sponge (bigger pores) and the lighter colour which is more like a dark grey than black.



■ **TMA-2012**

Sponge Rubber Tape 20 x 12 mm self-adhesive (compressed), reel at 12 m

This tape matches with the originally used sound-absorbing foam tapes between windscreen and dashboard. Therefore this endless foam tape on reel is ideal to replace the vehicle-specific sealing tapes, especially for all BMW series (1 series from 2004, 2 series from 2014, 3 series from 2005, 4 series from 2013, 5 series from 2003, 6 series from 2011, 7 series from 2008), various Audi series (A6 from 2011, A7 from 2010, A8 from 2004), as well as different Renault models (e. g. Espace, Mégane, Scénic).

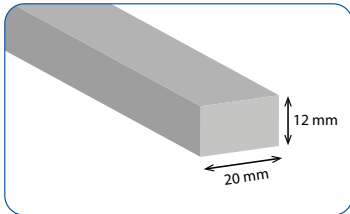

Due to its good acoustic properties (reduction of low-frequency vibrations) it makes sense to use this self-adhesive, slowly expanding foam tape also on many more vehicles for sound insulation purposes.

Delivery pre-compressed, that is to say that the height on the reel is only about 2 mm. After unreeling/applying the tape will expand very slowly and reaches its total height of 12 mm only after approx. 30 minutes. The windscreen shall be fitted directly after applying the tape, so that the windscreen adhesive has gained enough stability when the tape has expanded completely.



- **TAC-1210** Acrylic Tape transparent, 12 mm wide reel at 10 m
- **TAC-1910** Acrylic Tape transparent, 19 mm wide reel at 10 m
- **TAC-2510** Acrylic Tape transparent, 25 mm wide reel at 10 m
- **TAC-5005** Acrylic Tape transparent, 50 mm wide reel at 5 m

The entirely transparent adhesive tape is 1.0 mm thick and has an extraordinary high tack, also under high temperatures. It is virtually invisible! Most suitable for glass bondings if unobtrusive look is desired, e.g. for antennas and sensors.



- **TAT-1910** Acrylic Tape black, 19 mm wide extra thin 0.25 mm, reel at 10 m

The tape finds his application where is needed a very high adhesiveness but a very low interspace between the two glued parts.



- **TPC-1910** PET Tape transparent, 19 mm wide extra thin 0.2 mm, reel at 10 m

The tape finds his application where is needed a very high adhesiveness but a very low interspace between the two glued parts.



- **TAB-0910** Acrylic Tape black, 9 mm wide reel at 10 m
- **TAB-1210** Acrylic Tape black, 12 mm wide reel at 10 m
- **TAB-1910** Acrylic Tape black, 19 mm wide reel at 10 m
- **TAB-2510** Acrylic Tape black, 25 mm wide reel at 10 m
- **TAB-5005** Acrylic Tape black, 50 mm wide reel at 5 m

The deep black double-sided adhesive tape is 1.1 mm thick and has an extraordinary high tack, also under high temperatures. It is suitable to bond e.g. antennas on glass, to fix trims and emblems or to attach linings.



- **TF-0910** Polyethylene Tape dark-grey, 9 mm wide reel at 10 m
- **TF-1210** Polyethylene Tape dark-grey, 12 mm wide reel at 10 m
- **TF-1910** Polyethylene Tape dark-grey, 19 mm wide reel at 10 m
- **TF-2510** Polyethylene Tape dark-grey, 25 mm wide reel at 10 m

The dark-grey double-sided adhesive tape is 0.95 mm thick. It has very good final strength and is especially low-priced. It is most suitable to fix trims and for all other workings which use a lot of tape.



■ **TPO-3833**

Fixing Tape orange, perforated, 38 mm wide reel at 33 m

■ **TPO-7691**

Fixing Tape orange, perforated, 76 mm wide reel at 91 m

Especially designed to fix trims, to keep freshly bonded glasses from sliding and to mask the corners of a glass during storage and transport to prevent scratching. Thanks to the perforation (every 15 cm) this tape is very easy to portion from the reel.

The most important thing hereby is: This tape is removable without any residue and it does not corrode the surface of e.g. varnish, rubber or plastic.



■ **MTP-3850**

Premium Paper Masking Tape 38 mm wide reel at 50 m

High-grade paper masking tape with a special adhesive film - even after several days of application it does not leave any residue on a vehicle's paintwork, rubber and plastic parts. Due to the high stability (does not elongate noticeable) it is ideal to secure freshly bonded windcreens against sliding. Thanks to the paper carrier the tape can be sectioned very easily and is though very strong.



■ **MTG-5050**

Paper Masking Tape yellow, 50 mm wide reel at 50 m

Simple paper masking tape. Good stability (does not elongate easily) and therefore also suitable to secure freshly bonded windcreens against sliding. In short-term use this tape usually can be removed without residues and does not corrode the surface of e.g. varnish, rubber or plastic.

NOTE: In long-term use or when exposed to direct sunlight this tape can leave residues on the vehicle's varnish.



■ **STG-3850**

**Woven Adhesive Tape black, 38 mm wide
reel at 50 m**

■ **STG-5050**

**Woven Adhesive Tape black, 50 mm wide
reel at 50 m**

Very densely woven and strong adhesive tape to mask and protect all sensitive areas such as mudguard, bonnet edge, A-pillar and roof edge, while cutting out a glass with wires or hand knives. In short-term use this tape usually can be removed without residues and does not corrode the surface of e.g. varnish, rubber or plastic.

NOTE:

In long-term use or when exposed to direct sunlight this tape can leave residues on the vehicle's varnish.



■ **GTG-5050**

**Woven Adhesive Tape grey, 50 mm wide
reel at 50 m**

Very densely woven and strong adhesive tape to mask and protect all sensitive areas such as mudguard, bonnet edge, A-pillar and roof edge, while cutting out a glass with wires or hand knives. In short-term use this tape usually can be removed without residues and does not corrode the surface of e.g. varnish, rubber or plastic.

NOTE:

In long-term use or when exposed to direct sunlight this tape can leave residues on the vehicle's varnish.



■ **ATG-5050**

**Woven Adhesive Tape silver, 50 mm wide
reel at 50 m**

Strong woven adhesive tape to secure freshly bonded windscreens against sliding and for common jobs.

NOTE:

In long-term use or when exposed to direct sunlight this tape can leave residues on the vehicle's varnish.



■ **KRS-1588**

**Eraser Disk Ø 88 mm x 15 mm
to remove glue residues**

With this eraser disk all residues of adhesives can be removed without effort from car varnish or other surfaces. Just insert it to the cordless drill and erase the glue residues.



■ **KSR-5025**

**Fastener for road charge units,
10 strips at 5.0 cm**

- dimensions (WxH): 25 x 5.4* mm
- reclosable fastener tape with self-adhesive backside

*height for double sided use



■ **KSX-200**

**Fastener for road charge units,
roll at 2.0 m**

- dimensions (WxH): 25 x 5.4* mm
- reclosable fastener tape with self-adhesive backside

*height for double sided use



■ **TB-3006**

Butyl Tape Ø 3 mm, reel at 6 m

■ **TB-3010**

Butyl Tape Ø 10 mm, reel at 4.5 m

The thin butyl cord is e.g. excellent for gluing decorative frames before inserting the glass or protruding seals after assembly. The thick cord is great for sealing and grouting on mobile homes, trucks, buses, trains, etc.

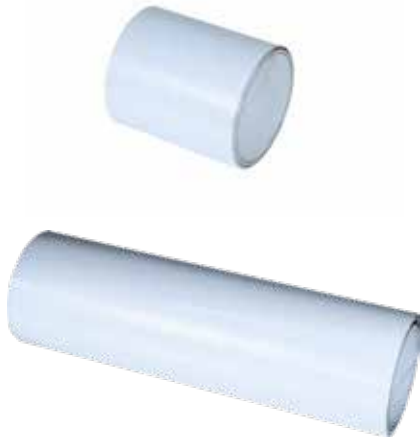

■ **SFT-1025**

Clear Protective Film, 100 mm wide reel at 2.5 m

■ **SFT-1525**

Clear Protective Film, 150 mm wide reel at 2.5 m

■ **SFT-2025**

Clear Protective Film, 200 mm wide reel at 2.5 m

■ **SFT-2525**

Clear Protective Film, 250 mm wide reel at 2.5 m

■ **SFT-3025**

Clear Protective Film, 300 mm wide reel at 2.5 m

The self-adhesive clear polyurethane foil has a smooth and glossy surface. It has been developed as a stone-chipping protection for painted car body parts. Thanks to the extreme elongation the film can be applied wrinkle-free to strongly curved parts, e. g. like the housing of a side mirror.

All painted surfaces like fenders, hoods or side mirrors can be protected against stone-chipping by applying this almost invisible film.



Technical data:

- film thickness: 200 µm
- elongation: 700 %
- temperature resistance: -40 to +120°C
- durability: 7-10 years
- delivery form: 2.5 m on cardboard reel (inside-Ø 76 mm)



■ **SFS-1550**

Black Protective Film, 150 mm wide reel at 5 m

This self-adhesive black protective foil has a medium structured surface. It is suited for covering B-pillars or door frames, as a stone-guard body protection or to protect the trunk sill.

Technical data:

- film thickness: 150 µm
- temperature resistance: -40 to +90°C
- durability: 7-10 years
- delivery form: 5 m on cardboard reel (inside-Ø 76 mm)



■ **PES-2500**

PE Protection Foil, self-adhesive, 82 cm wide reel at 25 m

■ **PES-0165**

PE Protection Foil, self-adhesive, 82 cm wide reel at 1.65 m, for one application



This foil is a temporarily substitute for damaged side or rear windows, to keep the vehicle mobile. The small reel is ideal to replace a toughened safety glass window and should always stay in your vehicle.

The self-adhesive, transparent PE foil (film thickness: 130 µm = 0.13 mm) is easy to attach. The bonding film is very strong and allows tight stretching when fixing. This reduces driving noise to a minimum. Crinkle-free mounting assures that the vehicle will stand even a heavier rain shower.

TIP: Due to the strong bonding film this foil should only be applied on varnishes that are in good condition. In doubt it is recommended to re-condition the area with a polishing compound. For removal you should warm up the film with a hot air gun - this will reduce the glue residues (possible residues can be removed with the eraser disc KRS-1588).



■ **PMS-3000**

Window Guard™ PE Protection Foil, self-adhesive, all 91.5 cm perforated, 91 cm wide, reel at 30 m

The protection foil is a temporarily substitute for damaged side or rear windows and keeps your vehicle mobile that way.

Window Guard™ is a self-adhesive, clear PE foil (film thickness: 83 µm = 0.083 mm) with a high level of transparency. Due to the perforation it is especially easy to attach. The bonding film is very strong and allows tight stretching when fixing. This reduces driving noise to a minimum. Crinkle-free mounting assures that the vehicle will stand even a heavier rain shower.

TIP: Due to the strong bonding film this foil should only be applied on varnishes that are in good condition. In doubt it is recommended to re-condition the area with a polishing compound. For removal you should warm up the film with a hot air gun - this will reduce the glue residues (possible residues can be removed with the eraser disc KRS-1588).



10

Other Hand Tools

10

Other Hand Tools



■ **SLP-101**

**Rope Insert Tool for passenger vehicles
tube outside-Ø: 6 mm, rope length: 6 m**

An indispensable tool for the replacement of glasses that are installed with a rubber gasket. With the curved tube you easily place the rope in the channel of the rubber profile. Thanks to the ergonomically shaped handle the rope does not carve into your fingers while installing the rubber moulded glass.

■ **SLP-101-01**

Replacement Rope 6 m for Rope Insert Tool SLP-101

Very flexible and high-tensile rope made of fine nylon netting.



■ **SLN-102**

**Rope Insert Tool for commercial vehicles
tube outside-Ø: 8 mm, rope length: 9 m**

An indispensable tool for the replacement of glasses that are installed with a rubber gasket. With the curved tube you easily place the rope in the channel of the rubber profile. Thanks to the ergonomically shaped handle the rope does not carve into your fingers while installing the rubber moulded glass.

■ **SLN-102-01**

Replacement Rope 9 m for Rope Insert Tool SLN-102

Very flexible and high-tensile rope made of fine nylon netting.





■ **LT-750**

Locking Strip Tool with 2 double end tips

General purpose tool with two double end tips = four different sized eyelets. Tips are fixed with a big knurled head screw and so no additional tool is required for turning and exchanging the tips. Suitable for locking strips of approx. 6 - 15 mm width.

■ **LT-750-1**

Replacement Eyelet Set (2 pieces) for LT-750

Inner dimensions of the eyelets:

7.5 (14.5) mm / 13.5 mm / 11.0 mm / 16.0 mm



■ **LT-415**

Locking Strip Tool with interchangeable eyelets

With this locking strip tool you can install all locking strips with a width from 8 - 19 mm. All eyelets can also be combined with the roller wheel (installed on the picture) to easily install locking strips.



■ **LT-415-1**

Replacement Eyelet Set (5 pieces) for LT-415

Inner dimensions of the eyelets:

9.5 mm / 10.5 mm / 11.5 mm / 12.5 mm / 13.5 mm

material thickness: 2.0 mm



■ **GHS-140**

Pointed Hook, with short shaft

total length: 200 mm



■ **GHS-280**

Pointed Hook, with long shaft

total length: 280 mm



■ **GHK-140**

Ball-Tipped Hook, with short shaft

ball-Ø: 4.5 mm

total length: 200 mm



■ **GHK-280**

Ball-Tipped Hook, with long shaft

ball-Ø: 5.0 mm

total length: 280 mm



■ **GH-738**

Pointed Hook, special shape „U“

The tridimensionally bent hook is great for working on rubber moulded glasses and for dismantling plastic panels.

total length: 210 mm



■ **GH-749**

Pointed Hook, special shape „V“

The tridimensionally bent hook is great for working on rubber moulded glasses and for dismantling plastic panels.

total length: 210 mm



■ **GH-753**

Pointed Hook, special shape „L“

The double bent hook is great to leverage a rubber profile over the pinchweld's edge.

total length: 190 mm



■ **AHL-818**

Equalizer Pointed Hook with long shaft

Pointed hook with long shaft and extra-long hook.

total length: 320 mm





■ **GBZ-200**

**Glass Breaking Pliers 200 mm long
jaw width approx. 25 mm**



■ **GBZ-225**

**Glass Breaking Pliers 225 mm long
jaw width approx. 25 mm**



■ **GC-130**

**Glass Cutter, full metal version
130 mm long**

- straight edge stand-off distance 1.8 mm
- cutting angle 120°



■ **GCK-119**

**Glass Cutter with rounded handle
119 mm long**

- straight edge stand-off distance 2.0 mm
- cutting angle 135°



■ **GCO-170S**

**Oil Glass Cutter with narrow head
170 mm long**

- heavy metal cutter
- narrow cutting head
- straight edge stand-off distance 2.5 mm
- cutting angle 135°
- handle made of aluminium with oil tank



■ **GCM-130**

**Glass Cutter with turnable head
130 mm long**

- straight edge stand-off distance 2.5 mm
- cutting angle 135°
- wooden handle

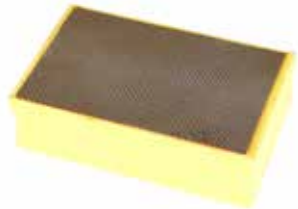

- **DSP-120** **Diamond Sanding Pad, black
grit 120**
- **DSP-200** **Diamond Sanding Pad, red
grit 200**
- **DSP-400** **Diamond Sanding Pad, yellow
grit 400**
- **DSP-800** **Diamond Sanding Pad, white
grit 800**
- **DSP-1000** **Diamond Sanding Pad, blue
grit 1000**

These handy foam blocks are coated with a flexible diamond sanding surface on one side.

The sanding pads are perfect for grinding small damages and irregularities on glass edges (NOTE: Please only grind the glass edges and never the glass surface!). Moreover they will work on all hard material, but also on many soft surfaces. Even rubber and plastic parts can be burred clean and easy.





■ **KM-130**

Putty Knife 30 mm wide, with solid wooden handle

■ **KM-140**

Putty Knife 40 mm wide, with solid wooden handle

■ **KM-150**

Putty Knife 50 mm wide, with solid wooden handle

These putty knives have a flexible steel blade with a big wooden handle and are very suitable to produce sealing joints on commercial vehicles, as well as other jointing work.

blade length: 110 mm

total length: 220 mm



■ **KM-9527**

Glazing Knife, straight shape

Glazing knife with wooden handle for glazing and jointing work.

blade length: 95 mm

blade width: 27 mm



- **FTL-430**
- **FTL-430-1**

LED Torch with flexible shaft

Replacement Bulb for FTL-430

Requires three 1.5 V Lady batteries (not included).



- **FTL-402**
- **FTL-402-1**

Mini Torch with flexible shaft

Replacement Bulb for FTL-402

The torch comes with a small removable magnet tip. This makes it easy to find and pick up lost screws in a vehicle. Requires two 1.5 V AA batteries (not included).



- **PLE-160**

LED Penlight

- Very handy and bright LED lamp with two magnet inside
- Shock-Proof aluminium body
- Weatherproof
- Turnable clip with a 120 degree swivel range
- Perfect for workshop and handcraft



- **LED-LIGHT**

LED Penlight

- Very lightness and handy LED Flashlight
- Sturdy aluminium body
- Weatherproof
- Perfect for garage and trade



■ WSL-180



LED Workshop Hand Lamp

- Very bright LED Light with two lamp and one magnet inside
- Handy and solid plastic body included a LED
- Turnable head included 4 LED with a 90 degree swivel range
- Adjustable Stand with a 180 degree swivel range
- Weatherproof IPX4
- Perfect for workshop and handcraft



■ SLL-100



LED Headlamp

- Very bright LED lamp with two modi (Steady Light 3 Step/Sensor 1 Step)
- Rechargeable Li-Ion Battery(charging cable included)
- Shock-Proof plastic body
- Turnable body with a 60 degree swivel range
- Weatherproof IPX4
- Perfect for workshop and handcraft



■ PL-140

LED Penlight

Ball-pen shaped LED torch with very bright LED. Made of painted tin and plastics. Requires two 1.5 V AAA batteries (**included**).



■ MSK-356

Magnet Bowl for small parts Ø 150 mm

The bowl can be placed almost everywhere on a vehicle because the bottom has a rubber cover to avoid scratches. The strong magnet surely holds the bowl itself and all magnetic contents.



■ **MH-120**

Telescopic Magnet

The telescopic magnet is a real multi-purpose tool. The extremely strong magnet is capable to lift and carry weights up to 1.5 kg! Extensible from 12 - 60 cm.



■ **MHF-510**



Magnetic lifter, flexible, 510 mm long

Magnetic lifter with flexible shaft for difficult and bad visible application.



■ **GHK-560**

Ball-Tipped Hook with extra long shaft

This extremely long tool is great for cleaning glass run channels in vehicle doors. By moving the round tip up and down in the run channel it will push out any loose parts without damaging the rubber.

ball-Ø 6.0 mm, total length: 540 mm



■ **FGR-440**

Flexible Grabber

Flexible Grabber with four claws for picking up small parts from difficult to reach areas.

Length 60 cm, max. opening of claws ca. 20 mm.



■ **TSP-2550**

Telescopic Mirror 25 x 50 mm

Small longish telescopic mirror with a clip to carry it in your shirt pocket, extendable from 11 - 44 cm.



■ **TSP-5050**

Telescopic Mirror Ø 50 mm

Big round telescopic mirror, extendable from 18 - 32 cm.



■ **ALS-185**

All-Purpose Cutter, 185 mm long

The handy formed All-Purpose Cutter allow trough his very smooth serrated blade a exactly and easy cut for the following material: Rubber, Plastic, Cardboard, Paper, Leather, Cable up to 2.0 mm, Wire up to 2.0 mm, Metal Sheet up to 0.8 mm and much more. Solid approved long-living construction.

Cutting length: 45 mm





■ **KSC-019**

Plastic Scraper, 19 mm wide

■ **KSC-025**

Plastic Scraper, 25 mm wide

Sturdy fiber-reinforced scrapers for the removal of bonded rails and badges.



■ **KSK-4510**

**Plastic wedges
set of 2 pieces**

The plastic wedges are made of an impact-resistant material.

length 10 cm, width 4.5 cm, height 2.3 cm



■ **KSK-29190**

Plastic wedge 190 x 29 x 24 mm

Perfect to wedge on the Windscreen during the cut out process even to straighten from fender, car door or to spread any kind of opening. Also usable for all work on molding, cover, door panel, rubber etcetera. Because of the shock-resistant and special plastic become all surface of the attachment and covering preserve.



■ RH-727

Rolling Work Seat 45 x 33.5 x 25 cm

Solid rolling work seat with three open compartments and one subdivided compartment under the lid. With four robust swivelling castors made of plastic (caster Ø: 50 mm).

- load capacity: 110 kg
- very good manoeuvrability thanks to the 360° swivelling casters
- practical compartments for tools and small parts
- for convenient working on door glasses
- also perfect for headlight restoration
- allows a knee- and back-friendly work position



■ RHR-410

Stepstool, approx. 41 cm high, made of plastic

- Plastic stepstool with spring loaded castors that retract when weight is applied.
- Tolerates heavy use without losing its look.
- dent-proof, scratch-proof, rust-proof
- Capacity: 150 kg





■ RT-560

Wheel Step Ladder
load capacity: 225 kg

- facilitates working on high vehicles
- simply put it over the front wheel, if necessary swivel in from the front
- applicable for almost all saloon cars, vans, SUVs and allterrain vehicles with a wheel diameter of at least 600 mm

Note: Due to the size of the wheel arch and the construction of the suspension strut not suitable for all vehicles



■ ULF-481

Ultrasonic Leak Detector

The ultrasonic leak detector makes it easy to find leak points quickly and reliably, e. g. on bonded glasses. The set includes an ultrasonic transmitter, a receiver and headphones. Requires two 9 V batteries (not included).

Note:

This device is operating with ultrasonic waves. Even smallest leaks can be indicated very reliably. But leaks on bonded vehicle glazings can only be found on dry vehicles! If the vehicle to test is wet you must first let it dry completely before you can use this leak detector to identify a leak on the adhesive bead. Also the glasses edge respectively the pinchweld must not be covered by any trims and mouldings. These parts will also hinder the ultrasonic waves and make it therefore impossible to find any leaks underneath.





■ **WSA-620**

Auto Glass Tool Cart, fully equipped



High-grade tool cart made of aluminium, plastics and coated steel plate. 4 swivel castors, thereof 2 with brake. 360° swivelmounted glass rack with 4 rubber cups for preparing glasses (item WSH-7050). The three top drawers are fully equipped with all hand tools needed to replace bonded and non-bonded glasses. And to keep everything in a nice order each tool has its own space in a rigid-foam lining. The three lower drawers without lining offer enough space for power tools or other big tools. In one of the high drawers for example we have put in the pair of suction lifters. To protect your tools all drawers can be locked with a central lock.

A paper roll holder (item PRH-380), a rod to hang the spray bottles, a 10 litre waste bin (item WAB-909) and two boxes for small parts such as clips and/or cans (items WKB-300 and WKB-400) are furthermore included.

item no.	description	item no.	description	item no.	description
PLE-160	LED Penlight	MH-140-WSP	Mini Hook 140 mm	SC-320	Scraper Blades 20 mm
MH-120	Telescopic Magnet	TS-135	ProGlass cutting Line TS	KFP-050	Pinchwelt Cleaning Brush
ZAW-090	Wiper Arm Puller, universal	P8	Spider cutting line P8	ALS-185	All-Purpose Cutter 185 mm long
HWA-2636	Wiper Arm Puller „EasyLift II“	WRD-LD	Line & wire dispenser	KSZ-163	Nozzle Cutting Pliers, made of plastic
WAV-899	Wiper puller Volkswagen Group	DST-757-WSP	Cutting Line Threader	FSC-150	ProGlass Pinchwelt Scraper
EWA-1702	Wiper Arm Puller, EasyLift	DBP-1824-WSP	Dashboard Protector 230 x 240 mm	GS-380	Glass Scraper with plastic handle
GHS-140	Pointed Hook, with short shaft	DBP-3316-WSP	Dashboard Protector 330 x 160 mm	MS-180	Installation Stick Round/Flat
GHS-280	Pointed Hook, with long shaft	DBP-4024-WSP	Dashboard Protector 400 x 240 mm	MS-181	Installation Stick Round/Round
CE-119	Clip Remover, flat/narrow	SB-886	Safety Goggles	OL-40	Olfa® Knife for 9 mm wide blades
MSL-265	Installation Lever flat/clip	ZMX-400	Pull Knife with quick release system	AB-10	Olfa® Snap-Off Blades, 9 mm wide
CEK-215	Clip & Strip Remover	UWG-3	UltraWiz Serrated Blade Assortment	MSK-356	Magnet Bowl for small parts
CEK-180	Clip & Strip Remover	KS-125	Body Filler Applicators in 3 parts	PSL-150-1	2-Cup Suction Lifter (2 pieces)
LHK-160	Trim Jack	KA-539	Cartridge Opener	WSH-7050	Glass Rack
MS-205	Installation Stick Pointed/Round	SRB-12	Pinchwelt scraper blade, 12 mm wide	PRH-380	Paper Roll Holder for tool cart
MHS-068	Hook and Pick Set	SRB-17	Pinchwelt scraper blade, 17 mm wide	WAB-909	Waste Bin for tool cart
STS-039	Socket Set 1/4 drive in 39 parts	RK-100A	Scraper Blades 40 mm wide	WKB-300	Accessory Box for tool cart
WSP-003K-SO	Cutting Tool SPIDER 3 (tool only)	SPZ-160	Pointed Pliers with wire cutter	WKB-400	Accessory Box for tool cart
AS-115-K	Anchor Suction Cup Ø 115 mm (plastic)	SC-313	Scraper Blades 12 mm	WSA-600-0	Auto Glass Tool Cart, empty
MS-180-WSP	Cutting line install tool	SC-316	Scraper Blades 16 mm		



■ **WSA-600-0**

Tool Cart, empty

Dimensions ca. (LxWxH): 800 x 450 x 985 mm

High-grade tool cart made of aluminium, plastics and coated steel plate. 4 swivel castors, thereof 2 with brake, four drawers with a height of ca. 55 mm and two big drawers with a height of ca. 125 mm. All drawers are 100% useable and can be locked with a central lock to protect your tools.

On the left side it has a rack to hang spray bottles, on the right side it has a grill to hook in boxes for small parts or other things.



■ **WSH-7050**



Glass Rack

The glass rack transforms the tool cart WSA-600-0 into an auto glass work centre. The rack can be swivelled by 360°. If required you can take it off the screw-mounted base very easily.

Dimensions incl. base and rubber plates (LxWxH): 98.5 x 60.0 x 16.0 cm
carrying capacity (if mounted on WSA-600-0): 60 kg

■ **PRH-380**



**Paper Roll Holder
for tool cart WSA-600-0**

Made of black powder coated metal tube. Max. roll diameter 34 cm, max. roll width 41 cm. Delivered incl. mounting parts.

■ **WAB-909**



**Waste Bin
for tool cart WSA-600-0**

Plastic waste bin to hang-on, capacity 10 l.

■ **WKB-300**

**Accessory Box for tool cart WSA-600-0
305 x 80 x 82 mm**

■ **WKB-400**

**Accessory Box for tool cart WSA-600-0
402 x 100 x 100 mm**



■ WSK-31

Tool Case with 31 tools

High-quality and robust tool case made of plastic. Equipped with all tools needed to exchange a bonded windscreen. With this case you are ready to go! The two perfectly cut foam linings are good to keep track of your tools. Every single piece has a tidy place. So you have your tools always at your fingertips and nothing disappears.

Kit contains:

- 1 SD-22 ProGlass sawing wire, braided, spool at 22 m
- 1 VKD-22 ProGlass cutting wire, squared, spool at 22 m
- 1 DGL-200 wire handles, self-locking (pair)
- 1 DHL-300 wire guide, long version
- 1 DST-733 T-handle wire threader, large
- 1 SPZ-160 pointed pliers with wire cutter
- 1 ZMX-400 quick release pull knife
- 1 UWG-3 UltraWiz Serrated Blade Assortment, in 3 parts
- 1 GS-380 glass scraper
- 1 RK-100A scraper blades 40 mm wide (package at 100 pieces)
- 1 FSC-150 ProGlass scraper, with quick change system
- 1 SC-313 scraper blades 12 mm, package at 10 pieces
- 1 SC-316 scraper blades 16 mm, package at 10 pieces
- 1 SC-320 scraper blades 20 mm, package at 10 pieces
- 1 XL-2 Olfa long knife
- 1 LB-10 Olfa snap-off blades, package at 10 pieces
- 1 MS-180 installation stick round/flat
- 1 LH-230 trim jack
- 1 CEG-148 clip remover, wide
- 1 GHS-280 pointed hook, with long shaft
- 1 GHS-140 pointed hook, with short shaft
- 2 PSH-120-1 ProGlass 2-cup suction lifter, single
- 2 FIX-080 moulding clamp, single
- 1 SHX-110 knitted gloves, size XL
- 1 SB-886 safety goggles
- 1 STS-039 socket set 1/4" drive in 39 parts
- 1 ZAW-090 wiper arm puller, universal
- 1 KSZ-163 V-notch pliers
- 1 KA-539 cartridge opener



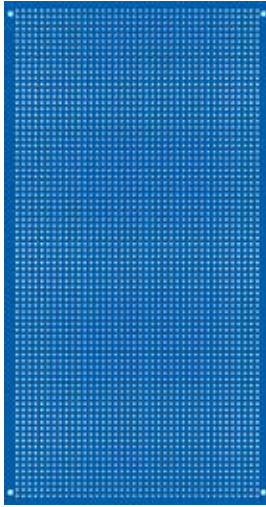

■ **IND-0609** **INDECO Perforated Tool Board**
960 x 480 mm, blue

INDECO tool board made of 1.5 mm perforated steel sheet. The boards are powder-coated and therefore very sturdy and durable. Due to a fine matrix of holes (12 x 12 mm hole spacing, 4.2 mm hole diameter) the board can be arranged individually.



■ **IND-601796** **INDECO Screw, single**

Each holder requires two screws. Do not forget to order, because commonly available screws are too long.

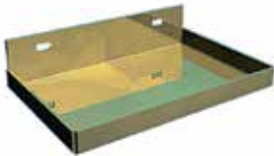

■ **IND-601099** **Shelf, 250 x 100 x 15 mm**

Solid shelf for small parts and tins or bottles. Made of electroplated steel panel.

■ **IND-601201** **Shelf 480 x 90 x 95 mm**



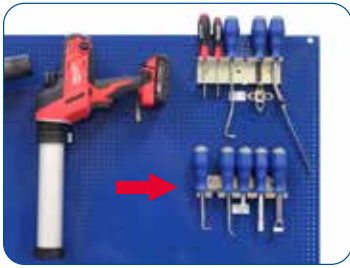

■ **IND-602030** Toolholder 200 x 56 mm

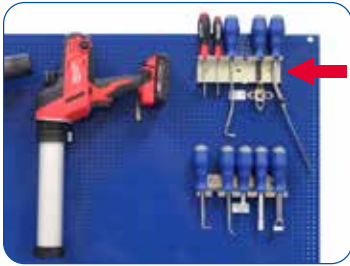

■ **IND-602060** Toolholder 189 x 60 mm



■ **MLW-455** Magnet tool holder 455 mm long



A clear and neat way to store tools. Each tool is always ready to hand. The strip is made of aluminium with clamps of plastic. It has two holes for wall fastening or to fix it onto a perforated tool board (delivered without tools).



■ **WH-440** Tool Holder 440 mm capable to hold up to 19 tools

A clear and neat way to store tools. Each tool is always ready to hand. The strip is made of aluminium with clamps of plastic. It has two holes for wall fastening or to fix it onto a perforated tool board (delivered without tools).



■ **IND-601703**
Holder, 45 mm long



■ **IND-601704**
Holder, 23 mm long
■ **IND-607703**
Holder, 45 mm long



■ **IND-601727**
Holder, 12 mm wide
■ **IND-601730**
Holder, 18 mm wide



■ **IND-601720**
Holder, 20 mm deep
■ **IND-601721**
Holder, 32 mm deep



■ **IND-601734**
Holder, for 1/2" box nut



■ **IND-601756**
Holder, Ø 21 mm,
height: 50 mm
one side closed



■ **IND-601723**
Holder, 20 mm round
■ **IND-601725**
Holder, 58 mm round



■ **IND-611071**
Tool Holder, 13-15 mm
■ **IND-611074**
Tool Holder, 25-27 mm



■ **IND-603070** Holder round Ø70 mm



■ **IND-603080** Holder round Ø80 mm



■ **SLK-S-17080** Storage Box Set 5 pcs.
Size: 170 x 100 x 80 mm Total length 520 mm

■ **SLK-17080** Storage Box
Size: 170 x 100 x 80 mm

- Variabel mountable
- Robust style
- Clear arrangement
- Stackable



■ **SLK-S-9050** Storage Box Set 5 pcs.
Size: 90 x 100 x 50 mm Total length 520 mm

■ **SLK-235130** Storage Box
Size: 235 x 160 x 130 mm

- Variabel mountable
- Robust style
- Clear arrangement
- Stackable

■ **CMU-099**

Allround Clips Storage Container with 99 compartments

Very spacious clips and small parts storage container with up to 99 compartments. Thanks to the variable dividers this container offers multiple fields of application. Made of shockproof plastic, with robust locks.

Delivery without content.

Dimensions: 420 x 300 x 410 mm



■ **CKM-021**

Clips and small parts storage box with 21 compartments

Small parts storage box made of milky-transparent, shockproof plastic, with robust locks. Thanks to the variable arrangement of the dividers you can create bigger or smaller compartments as needed.

Delivery without content.

Dimensions: 364 x 248 x 50 mm





■ **CMM-018**

**Clip storage cabinet
with 18 compartments**

Small parts storage case for mobile use. Perfect to organize clips, rubber spacers, sensor adhesive pads and other small parts. The 18 boxes can be taken out separately if needed.

Dimensions: 300 x 300 x 150 mm



■ **QT-5050**

Divider for clip storage cabinet CMM-018

The divider separates each box of the clip storage cabinet in two compartments.



■ **CKM-007**

Small parts storage box with 7 compartments

165 x 112 x 31 mm

delivered empty, without content



■ RW-201

Rolling Workshop STANLEY II

The rolling workshop Stanley II is the well-priced alternative made of plastic to the model „Professional“ (item no. RW-205).

The tool trolley can be demounted with snap closures in two parts for transportation.

Features:

- Removable tool tray in the top. Thereunder is a big compartment that offers enough room for a pair of suction cups.
- Drawer for tools or small parts.
- Higher drawer for tool storage.
- Big bottom compartment for power tools or other big tools.
- Extractable handgrip for convenient and easy transportation.

Delivery without Tools.

Dimensions: 448 x 348 x 778 mm





■ RW-205

Rolling Workshop STANLEY “Professional”

The rolling workshop offers enough space for all tools and supplies that the auto glass professional needs. Thanks to the compact dimensions this tool trolley is an excellent companion for the mobile service. With a single movement the tool trolley can be demounted in two parts for transportation.

Features:

- removable tool tray in the top
- thereunder is a big compartment that offers enough room for a pair of suction cups
- drawer for tools
- big bottom compartment for power tools or other big tools
- extractable handgrip for convenient and easy transportation
- retainer for extension cords or air hoses

Delivery without Tools.

Dimensions: 568 x 389 x 730 mm





■ **RW-217**

Rolling Workshop STANLEY FatMax

Features:

- Rolling workshop made of metal and plastic with two drawers, a large storage bin and a detachable, 30 cm high toll box
- 20" Detachable metal plastic tool box with removable tray
- Large metal rust proof latches with padlock eye
- Two deep 4" drawer with ball bearing slides
- One drawer with removable boxes for small parts
- Large metal storage bin that provides extra large capacity of portable tool storage
- Heavy duty 7" wheel

Delivery without Tools.

Dimensions: 568 x 389 x 893 mm





■ RW-239

Rolling Workshop STANLEY FatMax

Features:

- Rolling workshop made of plastic for the transport of large amounts of equipment and materials - saves time and effort on repeated trips to the van!
- Robust telescopic handle
- Opens up easily into a 4 level workstation
- Giant lower bin ideal for bulky equipment and tools
- Tool box with lift-out tray for smaller tools, which fits neatly into the fold-out lid

Delivery without Tools.

Dimensions: 549 x 413 x 733 mm



■ **WZK-7749-R Tool Box on wheels dimensions: 610 x 375 x 415 mm**

Robust and very spacious plastic box on wheels with an extendable handle. With two movable shelves and two further boxes for small items this case is the perfect companion in the mobile service.

The case can be used as a seat or pedestal. Maximum load is 100 kg.



■ **WZT-5836 Tool bag 580 x 360 mm**



The tool bag from a very strong Nylon was specially concept for workplace with missing storage place for small tools. (Such as windscreen trestle, workbench and open tool carts). Also for mobile job.

Delivered empty, without content.







■ **EWS-620**

ProGlass Windscreen Trestle Economy

- well-priced and nevertheless sturdy windscreen trestle
- made of shock-resistant lacquered steel tube
- soft coating is made of non-skid material and particularly resistant
- width multi adjustable to carry almost all sizes of glasses
- delivered completely mounted
- load capacity: 80 kg



■ **HWS-760**

■ **HWS-680**

ProGlass Windscreen Trestle Heavy Duty

ProGlass Windscreen Trestle Heavy Duty

- very sturdy version - load capacity up to 100 kg
- made of shock-resistant lacquered steel tube Ø 30 mm
- soft coating is made of non-skid material and particularly resistant
- width multi adjustable to carry almost all sizes of glasses
- delivered demounted, with illustrated manual (assembly in about 5 minutes)

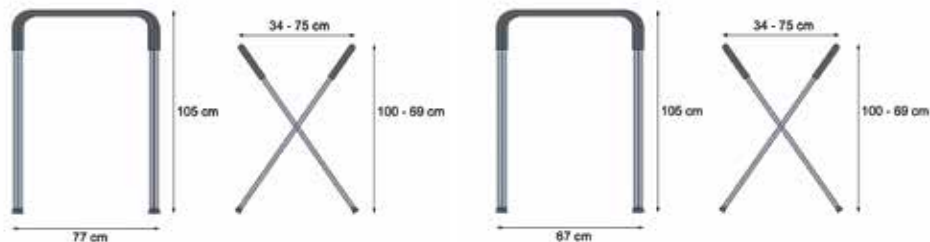

HWS-760

HWS-680



SWS-580-01

■ SWS-580

Windscreen Trestle Standard

■ SWS-580-01

Rubber Plates for SWS-580, single

- classical design, made of lacquered steel tube Ø 25 mm
- four big rubber plates to hold the glasses firmly
- width multi adjustable to carry almost all sizes of glasses
- delivered partly mounted
- load capacity: 60 kg



■ NWS-1080

ProGlass Windscreen Trestle Heavy Duty for commercial vehicles and trucks



- very sturdy version - load capacity up to 100 kg
- made of shock-resistant lacquered steel tube Ø 30 mm
- soft coating is made of non-skid material and particularly resistant
- width multi adjustable to carry different sizes of glasses
- extra large frame length for tall and heavy glasses
- delivered demounted, with illustrated manual (assembly in about 5 minutes)

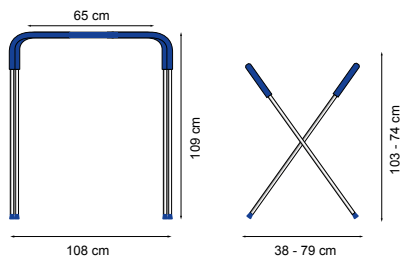

■ **SWW-880**



ProGlass Windscreen cart with three floors

High-quality processed windscreen trolley made of plastic and aluminum. The trolley consists of three levels including four rubber plates for placing and preparing windshields.



■ **SGS-05**

Glass Rack with 5 compartments, non collapsible

■ **SGS-09**

Glass Rack with 9 compartments, non collapsible

- rack completely made of high-grade painted steel
- non-skid rubber cams and supports hold all sizes of glasses firmly
- tubes are all padded with resistant material
- rack delivered completely mounted, ready to bolt to the vehicle's bottom (fixing material included)

Data SGS-05:

- height: 81 cm
- width: 54 cm
- depth: 60 cm
- net weight: 11,5 kg



Data SGS-09:

- height: 83,5 cm
- width: 81 cm
- depth: 60 cm
- net weight: 16,4 kg





■ **SGM-05**

ProGlass Glass Rack with 5 compartments, collapsible

■ **SGM-09**

ProGlass Glass Rack with 9 compartments, collapsible

- rack completely made of high-grade aluminium - this means no peeling off paint, no rust
- non-skid rubber cams and supports hold all sizes of glasses firmly
- tubes are all padded with resistant material
- rack delivered completely mounted, ready to bolt to the vehicle's bottom (fixing material included)
- in case of disuse, collapsible in a few seconds by pulling out the locking pins

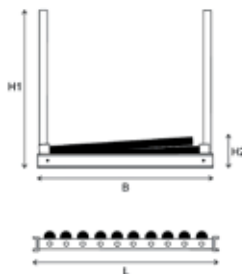

Data SGM-09

L = 83 cm
 B = 77 cm
 H1 = 55 cm
 H2 = 12 cm
 Weight: 13.7 Kg

Data SGM-05

L = 52 cm
 B = 77 cm
 H1 = 55 cm
 H2 = 12 cm
 Weight: 8.5 Kg

■ **SRW-006**

Glass Rack, wall-mounted, with 6 compartments

Rack completely made of high-grade painted steel. Non-skid rubber caps and foam upholstery hold all sizes of glasses firmly and give a full bearing. Rack delivered with diverse fixing material.



- Dimensions: 710 x 585 x 120 mm
- Pipe Diameter: 34 mm
- Pipe Length: 665 mm
- Pipe Distance: 40 mm
- Weight: 9400 g





■ **PSL-150-1**

ProGlass 2-Cup Suction Lifter „Pro Deluxe“

Easier and safer to attach than common suction lifters with clamp lever technology - the bell-shaped rubber pads already adhere onto the glass surface with slight pressing - even before pressing down the lever!

- 2 concave suction cups with large seal avoid slipping or coming off
- pin-jointed heads for an optimum hold on all curved glasses
- slotted handle to pass a belt through
- load capacity for each lifter is 60 kg
- frame made of light-weight and shock-resistant plastic
- diameter of suction cup 150 mm



■ **PSH-120-1**

ProGlass 2-Cup Suction Lifter „Pro“

- pin-jointed heads for optimum hold on curved glasses
- slotted handle to pass a belt through
- load capacity for each lifter is 60 kg
- frame made of light-weight and shock-resistant plastic
- diameter of suction cup 115 mm





■ PHX-150-1

ProGlass Single Suction Lifter „Pro Deluxe“

- single-cup suction lifter for one-hand operation with concave suction cup 150 mm
- load capacity 30 kg
- for easier and safer handling
- frame made of light-weight and shock-resistant plastic



■ PHL-115-1

ProGlass Single Suction Lifter „Pro“

- handy single-cup suction lifter for one-hand operation
- diameter of suction cup 115 mm
- load capacity 30 kg
- frame made of light-weight and shock-resistant plastic



■ HRS-100

ProGlass Adhesive Agent For Suction Cups can at 100 ml



It highly degreases the rubber and improves the adhesion between rubber and glass (the glass must be clean as well). Other cleaning agents with a similar efficient formula will destroy the rubber surface within short time.

■ **DSA-125-1 3-Cup Suction Lifter „Pro“**

- Extremely secure because of three stand-alone suction pads
- Very robust aluminium body
- Diameter suction pad 123 mm
- load capacity 100 kg



■ **SHE-070 Hand-held Suction Lifter Ø 70 mm, load capacity 8 kg**

The vacuum lifter with pistol grip and one-hand locking handle is especially suitable for exchanging mirror glasses as well as for setting small quarter glasses. To release the vacuum push the grey-coloured release button.



■ SHP-150



ProGlass Vacuum Lifter Kit

Kit contains:

- 2 single vacuum lifters SHP-150-1 (Ø 150 mm)
- 1 elbow pad
- 1 plastic case 365 x 200 x 180 mm
- load capacity for each single lifter is 60 kg

■ SHP-150-1

ProGlass Vacuum Lifter, single



Easier and safer to attach than common suction lifters with clamp lever technology - the bell-shaped rubber pads already adhere onto the glass surface by slightly pressing them down!

- concave rubber pad (Ø 150 mm) for optimal hold, also on strongly curved glass surfaces
- fixed with the integrated vacuum pump
- safety ring at the pump plunger for optical monitoring of the vacuum
- load capacity for each single lifter is 60 kg



■ **SHP-200-1**

Vacuum Lifter with curved suction cup for heavy glasses single, in plastic case

- concave rubber pad (Ø 200 mm) with multiple-seal lip for optimum hold, also on strongly curved glass surfaces
- fixed with the integrated vacuum pump
- red safety ring at the pump plunger enables optical monitoring of the vacuum
- load capacity for each lifter is 80 kg



■ **SHP-230-1**

Vacuum Lifter for heavy glasses single, in plastic case

- large rubber pad (Ø 230 mm) with multiple-seal lip for optimum hold, also on slightly curved glass surfaces
- fixed with the integrated vacuum pump
- red safety ring at the pump plunger enables optical monitoring of the vacuum
- load capacity for each lifter is 120 kg





■ **SHV-125-1**

2-Cup Suction Lifter, single with 1-hand-operation

- Particularly flexible concave rubber pads fit onto all glasses
- fast 1-hand-operation for serial assembling or transportation
- diameter of rubber pad is 125 mm
- load capacity for suction lifter is 40 kg



1 place it on the glass



2 press it down



3 done!



4 pull lever to release

■ **JP-135**

■ **JP-140**

Vacuum Lifter JetPack with AirForce Technology

Vacuum Lifter Kit JetPacks with AirForce Technology

Simple and safe installation, thanks to the curved pad the suction cup sticks already if you press it down. The suction is done fully automatically by an electronically controlled vacuum technology. If there is a loss of pressure, the system adjusts itself automatically, so that the suction cup cannot be detached. (Only when electronics are switched on)

- Curved suction pad (Ø 180 mm) for optimal adhesion, also on strongly curved glasses
- Load capacity for each lifter is 70 kg





■ **SHG-200**

Single Suction Cup with spherical rubber pad

- spherical rubber pad also fits extremely curved glasses
- fast application without lever or pump
- suction cup diameter: 165 mm
- material: rubber
- load capacity per piece: 20 kg

■ **GT-3516**

Window Carrier

The window carrier allows you to easily carry large windows without the use of suction lifters and with only one person. Made of fiber-reinforced plastic.



■ **RTD-509**

Pair of Ratcheting Tie Downs

- to secure freshly bonded-in glasses
- with German TÜV/GS symbol that stands for proved safety
- solid ratcheting mechanism
- length of each belt: 5 m





■ **WSR-800**

**Automated Windscreen Repair System
WSR-800 GECKO**

■ **WSR-800K**

**Automated Windscreen Repair System
WSR-800 GECKO with case**



quicklink to the
website



The **WSR-800 GECKO** system is the highly-automated and user-friendly solution for perfect windscreen repairs.

In the latest Generation 4 of the computer-controlled repair system, the electronics and software have been revised and improved once again. All work steps are integrated into an automatic programme. The new 5.0 inch colour display guides the operator and keeps him informed about the repair progress. The process reliability realised in this way enables every employee to carry out a repair effortlessly and without errors - and always with optimal results.

- new 5.0 inch colour display
- improved electronic control
- optimised software

The repair fixture works with a two-chamber pressure/vacuum system. The outer chamber holds the fixture safely attached to the glass surface with a permanent vacuum. Through the inner chamber the glass damage is vacuumized, the resin injected and the chamber pressurized and vacuumized in several cycles. The UV lamp with high-power LEDs cures the repair completely in only 50 seconds.

Visit the GECKO website at www.gecko-repair.com!

GECKO

✓ patented repair system

✓ simple operation

✓ minimal time required

✓ effective damage repair



■ WSR-800W

Automated Windscreen Repair System WSR-800 GECKO with tool cart



By combining the WSR-800 GECKO repair system with the WSW-800 workshop trolley, you always have a workstation ready for stone chip repair. The GECKO stands on the upper shelf at a comfortable working height, the consumables and the components find their place in the lockable drawers. The two platforms underneath offer generous storage space for cleaning paper, window cleaners, vehicle protectors, etc.

■ WSW-800

Tool Cart with three floors & two drawers



High-quality workshop trolley made of plastic, aluminum and painted drawers made of sheet steel. The trolley consists of three floors including two drawers with a height of approx. 107 mm and 155 mm. Both drawers have a full extension and can be locked to protect against unauthorized access.

- Dimension: 750 x 460 x 1103 mm
- Loading capacity: 150 Kg
- Working height: 968 mm
- Drawer Dimension: 504 x 383 x 54/110
- Weight: 24.4 kg
- Material: Plastic / Metal
- Color: Grey



■ **WSR-800K-BO Booster for WSR-800/K**

The NOMAD POWER PRO 700 is a lithium-based power pack. **With special adapter cable for mobile use of the WSR-800/K (up to 10 x repairs possible per battery charge).**

It combines 4 functions:

- Battery-Supplied jump start (Booster) for 12V vehicle (motorcycle, quad, car ect.)
- independent supply for all current electrical equipment (smartphone, tablet, computer, ect.)
- Emergency lamp
- 2 x USB-Ports 5V, for charging smartphone, tablet, GPS, ect.
- 1 x 15V (10A), ideal for camping, to supply a 12V electrical appliance (cool box, fan, ect.)

■ **WSR-800-7 Power cable 12 V, length 7.5 m, for ProGlass WSR-800 GECKO**



With the 12 V connection cable, the GECKO becomes mobile!

Simply connect this power cable to the GECKO instead of the AC power supply and connect the battery terminals to the 12 V vehicle battery of your own vehicle or to a portable booster and you can use your GECKO for mobile repairs on site.

ATTENTION:

Not suitable for 1st generation WSR-800 devices (serial number starting with 1.00xxx).

The cable is only suitable for the WSR-800 GECKO!

■ **WSR-800-PH Positioning aid for WSR-800 GECKO, consisting of 2 templates**

■ **WSR-800-PHS Positioning set for WSR-800 GECKO, contains 2 templates and 1 chalk marker**



The positioning aid makes it easier to fit the GECKO repair unit precisely when an inspection mirror cannot be used. For example, for repairs on locked vehicles or if it is not possible to attach the mirror from the inside, or for repairs in the black area of a windscreen.

1. Remove the protective film and place the template made of static adhesive film exactly over the point of impact.
2. Run around the template with the chalk marker.
3. Lift off the template again and position the repair unit according to the chalk contour.

■ **DRV-500**

Repair Fixture Seal for WSR-800, 1 piece



The V-seal is responsible for the secure hold of the repair base on the window. The material (NBR) has medium resistance to the chemicals used. Frequent contact with resin, however, can cause swelling. In this case, and in the event of any mechanical damage, the seal must be replaced.

■ **DRO-116**

Injector/Resin Tank Sealing Kit, in 6 parts for WSR-800



The set contains 2 seals for the resin tank (Ø 11.6 mm), the resin chamber (Ø 7.5 mm) and the injector (Ø 11.6 mm). The material (MVQ - silicone rubber) has good chemical resistance. This means that the seals keep their shape despite regular, direct contact with the repair resin. However, we recommend replacing all three seals after 6 months, as there is a certain amount of wear / abrasion during use.

Set consisting of:

- 4 MVQ O-rings, red, Ø 11.6 mm
- 2 MVQ O-rings, red, Ø 7.5 mm

■ **MSF-010**

Multi Silicone Grease, tube at 10 ml



Highly adhesive, transparent silicone grease for the care of the O-rings on the plug connections of the WSR-800 GECKO. Regular use of silicone grease will significantly increase the life of the seals.

Attention: Do not use for seals made of MVQ (silicone rubber). These could be resolved.

■ **WSR-800-1**

Repair Fixture for ProGlass WSR-800 GECKO



Complete repair fixture with resin chamber and connections. Can only be used in connection with the repair system WSR-800 GECKO (as well as the WSR-800 of the 1st generation). The repair fixture is sucked to the window via the black connection using negative pressure. The blue connection acts on the resin chamber with negative and positive pressure. If you suspect a defect in your fixture or only need individual parts, please contact our sales department.

■ **WSR-800-3**

Tray for Repair Fixture for ProGlass WSR-800 GECKO



The tray is attached to the windscreen near the damaged area. So it guarantees a safe and comfortable workflow.

Before the repair:

- Hang the couplings of the connecting hose in the two recesses at the bottom.
- Hang the repair fixture in both arms, fill the resin tank, connect the hose couplings.

After the repair:

- Disconnect the hose and hang it into the two recesses.
- Remove the repair fixture and hang it in both arms again.

■ **UVN-806**

UV lamp for WSR-800 GECKO



UV lamp with 6 high-performance LEDs. Can only be used in conjunction with the WSR-800 GECKO repair system.

ATTENTION:

Not suitable for WSR-800 devices of the 1st generation (serial no. starting with 1.00xxx). Please always state the serial number of your device in the event of damage or when ordering spare parts.

■ **WSR-800-4** **Connection Hose for ProGlass WSR-800 GECKO**



The hose has a length of approx. 3.0 m and connects the WSR-800 GECKO to the repair base.

ATTENTION:

Not suitable for WSR-800 devices of the 1st generation (serial no. starting with 1.00xxx). Please always state the serial number of your device in the event of damage or when ordering spare parts.

■ **WSR-800-5** **Y-Connection Hose for ProGlass WSR-800**



The Y-hose enables the simultaneous, parallel repair of two stone chips with the repair system WSR-800 GECKO (or the WSR-800 of the 1st generation).

In addition to the Y-hose, at least one additional repair base WSR-800-1 and an extension WSR-800-6 are required.

■ **WSR-800-6** **Extension Hose for ProGlass WSR-800**



The hose has a length of approx. 3.0 m and can be used to increase the range of the original connection hose of the WSR-800 GECKO (or WSR-800 1st generation).

Alternatively, the extension can also be used with the Y-connection hose WSR-800-5. One or two extensions (in parallel on the output side) can be used here.

In any case, the maximum hose length of approx. 6.0 m must be observed.

- WSR-300
- WSR-300-1

Automated Windscreen Repair System, battery powered

Pressure / Vacuum Unit TERMINATOR, computer-controlled repair unit

The heart of the system is the Terminator® - a computer-controlled pressure/vacuum unit, which can be used anywhere with its rechargeable battery power supply.

This innovative laminate glass repair system allows the installer to carry out the highest quality repairs to all stone damages, after just a short training session. After applying and filling the injector unit, the Terminator® completes the repair, i.e. injects the repair resin into the damaged area using targeted cycles of pressure and vacuum, without any further intervention from the operator. **This gives perfect repair results every time!**

Combined with the renowned ProGlass injector unit, you'll get an extremely user-friendly system. After filling the resin chamber, the Terminator® is connected to the injector unit via a flexible hose. Select the right program on the device (star, bullseye, or express) and start the repair process. **The pressure/vacuum unit carries out the process independently** and gives the installer an audible and visual signal when the program is finished. Then you take the injector unit off and the repair is hardened and polished as normal with epoxy resin.

The ingenious process is based on more than 20 years of experience in laminate glass repair and delivers optimal filling of damaged areas without air pockets. This raises the quality of your repairs and reduces the effort involved at the same time. Even an inexperienced installer can obtain perfect results with this innovative repair system.





WSR-300 kit contains:

- Automatically Processor battery-operated (WSR-300-1)
- ProGlass Repair Fixture (WSR-150-1N)
- Resin Chamber small, 3/16 inch (WSR-150-2N)
- Connection Hose (WSR-300-3)
- Inspection Mirror with Sucker (MC-500)
- LED UV Lamp 2 W (12V) (UVA-200-LED)
- Cordless Mini Drill 3.6V (AM-361)
- Carbide Probe (CP-5040)
- Cracker (CRK-109)
- LED Penlight (PLE-160) batteries included
- Lighter, childproof (FZ-8326)
- 1 Repair Resin, 15 ml (VR-515)
- 1 Pit Refiller Resin, 15 ml (VR-415)
- 1 Glass Repair Polish, 25 ml (SP-025)
- Accessory Box contains:
 - 3 Syringes (1942)
 - 3 Cannulas (2496)
 - 20 Mylar Squares (MR-300)
 - 10 Scraper Blades (RK-10)
 - 5 Injector O-seals 3/16 inch (DR-475)
 - 1 Carbide Drill Bit, tapered 0,8 mm (KMB-085-1)
 - 1 Carbide Drill Bit, tapered 1,0 mm (KMB-105-1)
 - 1 Carbide Drill Bit, round 1,0 mm (KMK-110-1)
 - 1 Carbide Drill Bit, round 1,2 mm (KMK-120-1)
 - Grinding and Polishing Kit, 6 pieces (AM-360-FPS)
 - Bull's-Eye Maker (SSK-790)
- Dome Magnifier (SL-015)
- Detailed instruction manual
- Advertising poster (actually only for A, CH, D) (WSR-150-P)
- Rugged Plastic Case 575 x 472 x 206 mm with rigid-foam lining

WSR-300-1 kit contains:

- Pressure / Vacuum Unit Terminator (R)
- Li-Ion Battery 22.2 V / 2.7 Ah (WSR-300-1-BA)
- Charger (WSR-300-1-LG)

An extension to your existing ProGlass windscreen repair system WSR-150-A / WSR-150-N



■ **WSR-150-N**

Professional Windscreen Repair Kit for stationery use

■ **WSR-150-A**

Professional Windscreen Repair Kit for mobile use



This professional windscreen repair kit is a result of our longtime experience in windscreen repair. It contains all components necessary for professional work and for optimum results. Almost no other system is equipped so completely as this kit. By that the price is remarkably favorable - do not hesitate to compare the contents list to systems from other suppliers.

The stationary kit includes a 230 V mains operated UV lamp. The mobile kit includes a 12 V operated UV lamp that connects with a cigarette lighter or vehicle power outlet.

Besides the large range of tool components, the kit also includes all consumables for at least 20 repairs. Each of these consumables can be bought later separately and at fair prices.

Features:

- high-quality and long-life components
- very complete professional case for all kinds of stonechips
- all components and consumables also available separately
- detailed instruction manual included

quicklink to the product video





Steinschlagschaden?
Kostenlose* Reparatur HIER!!!

* die Teilhaskoversicherung übernimmt die Kosten der Reparatur in der Regel in voller Höhe - trotz vereinbartem Selbstbehalt

Die meisten Steinschlagschäden an Windschutzscheiben sind reparabel. Sprechen Sie mit uns darüber!

Wir informieren Sie gerne zu den technischen Möglichkeiten und den Vorgaben und Einschränkungen des Gesetzgebers.

© Elias

WSR-150-P

Kit contains:

- ProGlass repair fixture (WSR-150-1N)
- resin chamber small, 3/16" (WSR-150-2N)
- connection hose (WSR-150-3)
- pressure/vacuum pump (WSR-150-5)
- inspection mirror with suction cup (MC-500)
- LED UV Lamp 2 W (230V / 50 Hz) (UVN-200-LED)
 or LED UV Lamp 2 W (12V) (UVA-200-LED)
- cordless mini drill 3.6V (AM-361)
- carbide probe (CP-5040)
- cracker (CRK-109)
- LED Penlight (PLE-160) incl. batteries
- lighter, childproof (FZ-8326)
- 1 repair resin, 15 ml (VR-515)
- 1 pit filler resin, 15 ml (VR-415)
- 1 glass repair polish, 25 ml (SP-025)
- 1 dome magnifier 15x (SL-015)
- accessory box with following contents:
 - 3 syringes (1942)
 - 3 cannulas (2496)
 - 20 mylar squares (MR-300)
 - 10 scraper blades (RK-10)
 - 5 injector seals 3/16" (DR-475)
 - 1 carbide drill bit, tapered 0.8 mm (KMB-085-1)
 - 1 carbide drill bit, tapered 1.0 mm (KMB-105-1)
 - 1 carbide drill bit, round 0.8 mm (KMK-110-1)
 - 1 carbide drill bit, round 1.0 mm (KMK-120-1)
 - 1 grinding and polishing kit, in 6 parts (AM-360-FPS)
 - 1 bull's eye maker (SSK-790)
- detailed instruction manual
- advertising poster (actually only for A, CH, D)
- rugged, foam lined plastic case
 500 x 420 x 125 mm



■ **WSR-150-1N ProGlass Repair Fixture (without resin chamber!)**

The 125 mm big sucker of the fixture is mounted to the glass securely by pushing the pump plunger only a few times (optical control through red safety ring on the pump). The solid light alloy arm is movable and swivelling so that the resin chamber can be adjusted over the impact point easily and very precisely.

By turning the screw downward the resin chamber will become vacuum-sealed to the glass. Thanks to the spherical seat the resin chamber will align itself at right angle over the impact point. This guarantees that the seal does not impose more pressure upon the glass than necessary.



■ **WSR-150-2N ProGlass Resin Chamber, 3/16" for all standard repairs**

The seal of this chamber has an inside Ø of 4.75 mm. It is dedicated to perform all standard repairs with an impact no bigger than 5 mm. The chamber can be used for repairs on all flat and vertical glasses.

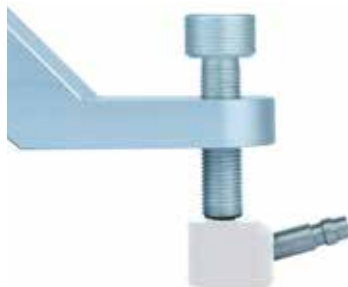

■ **WSR-150-6N ProGlass Resin Chamber, 3/8" for the repair of large damages**

The seal of this chamber has an inside Ø of 9.5 mm. It is suitable for large stone chips as could be found at commercial vehicles or busses. Due to its extra large size, it is also applicable for two impact points close to each other. The chamber can be used for repairs on all flat and vertical glasses.



■ **WSR-150-5** **Pressure/Vacuum Pump for WSR-150**



Pressure/vacuum pump for our ProGlass Professional Windscreen Repair Kit WSR-150. Also compatible to other repair systems on the market, e. g. AEGIS or Würth.

■ **WSR-150-3** **Connection Hose for WSR-150 / Total length: 96 cm**

■ **WSR-300-3** **Connection Hose for WSR-300 / Total length: 166 mm**



The hose connects the pressure/vacuum pump with our resin chambers. It is also compatible to other repair systems on the market, e. g. AEGIS or Würth.

■ **SHU-3237** **Suction Holder, universal, Ø 32-37 mm**



Use the suction holder to fix the pressure/vacuum pump WSR-150-5 to a windscreen or to other smooth surfaces. This is for example very helpful when repairing windscreens on commercial vehicles.

■ **RF-050** **Refill Kit for WSR-150 / 300
sufficient for at least 50 repairs**



Kit contains:

- 2 repair resins (item no. VR-515)
- 1 pit filler resin (item no. VR-415)
- 2 injector seals (like item no. DR-475)
- 10 scraper blades (item no. RK-10)
- 50 mylar squares (like item no. MR-300)
- 4 syringes (item no. 1942)
- 2 cannulas (item no. 2496)



■ **RS-2030**

Resin Dispensing Kit

Kit contains 6 syringes item 1942 and 3 cannulas item 2496 for the laminated glass repair.



■ **1942**

Syringe (polypropylene), 1 ml

Reusable syringe made of polypropylene for exact dosage of resin.



■ **2496**

Cannula 2.0 x 70 mm

Reusable cannula made of stainless steel for exact dosage of resin in connection with the syringe 1942.



■ **FZ-8326**

Lighter „ProGlass“, blue

Refillable pocket lighter.



■ **VR-515**

**Repair Resin ExtraPlus, extra thin,
dropper bottle at 15 ml**

Extra thin repair resin, excellent crack filler.

viscosity at 25°C: 10-20 mPa*s
shore hardness: D75



■ **VR-415**

**Pit Filler Resin Extra, thin,
dropper bottle at 15 ml**

More fluid pit filler, for a hard and shiny finish.

viscosity at 25°C: 90-100 mPa*s
shore hardness: D80



■ **DR-475**

**Injector seals 3/16" for repair system WSR-150 / WSR-300
package at 5 pieces**

Injector seal (small) for the resin chamber WSR-150-2N.

inside-Ø approx. 4.75 mm, outside-Ø ca. 9.75 mm



■ **DR-950**

**Injector seals 3/8" for repair system WSR-150 / WSR-300
package at 5 pieces**

Injector seal (large) for the resin chamber WSR-150-6N.

inside-Ø ca. 9.5 mm, outside-Ø ca. 16.0 mm



■ **WSR-100**

ProGlass Windscreen Repair Kit for stationary use

■ **WSR-100-A**

ProGlass Windscreen Repair Kit for mobile use

Simple and economic repair system for the professional windscreen repair. The system WSR-100 is distinguished for businesses with a lower repair volume or as a second system.

In this system the pressure and vacuum needed to perform a repair is produced by screwing the plastic injector's piston in and out. The simple construction of the whole system ensures a safe and easy operation. Thanks to the high-quality and extremely thin ProGlass repair resin even finest cracks can be repaired. The system can also be used to repair damages with a finely smashed or very dirty point of impact because an electric mini drill is also included.

Kit contains:

- ProGlass repair fixture ([WSR-100-1](#))
- inspection mirror with sucker ([MC-500](#))
- LED UV Lamp 2 W (230V / 50 Hz) ([UVN-200-LED](#)) or LED UV Lamp 2 W (12V) ([UVA-200-LED](#))
- Cordless Mini Drill 3,6 V with charging unit, collet set and polishing set ([AM-361](#))
- carbide probe ([CP-5040](#))
- cracker ([CRK-109](#))
- Penlight ([PL-140](#)), batteries included
- lighter, childproof ([FZ-8326](#))
- suction cup lubricant, 60 ml ([VS-060](#))
- glass repair polish, 25 ml ([SP-025](#))
- polishing kit in 6 parts ([AM-360-FPS](#))
- accessory box with following contents:
 - 2 plastic injectors ([INJ-M14-F](#))
 - 1 repair resin, 5 ml ([VR-505](#))
 - 1 pit filler resin, 5 ml ([VR-405](#))
 - 20 mylar squares ([MR-300](#))
 - 10 scraper blades ([RK-10](#))
 - 1 carbide drill bit, tapered 1.0 mm ([KMB-105-1](#))
 - 1 carbide drill bit, round 1.0 mm ([KMK-120-1](#))
- detailed instruction manual
- rugged plastic case 450 x 360 x 106 mm with rigid foam lining



■ **WSR-100-1** **Repair Fixture for WSR-100**



Injector holder made of aluminium with two PVC suction cups (Ø 37 mm). For the simple and safe positioning of the injector over the point of impact. Comes with one injector INJ-M14-F.



■ **INJ-M14-KIT** **Repair Resin with Injector**

Kit consisting of one bottle with 5 ml repair resin ExtraPlus and one plastic injector.



■ **INJ-M14-F** **Injector for Windscreen Repair**

Well-priced injector for the ProGlass WSR-100 windscreen repair kit. Compatible with many repair systems on the market like for example Duobond, PMA or Talon (metric fine thread: M12x1,25).



■ **INJ-007-DI** **Seal for INJ-M14-F Injector Ø 7.0 mm, package at 5**

Suitable for all injector with attached inside dimension:

- Length: 17,0 mm
- Diameter: 7,0 mm
- Plunger Diameter: 4,5 mm

Windscreen Repair Resins

Our resins for laminated glass repair can be used with all repair systems on the market. They cure by radiation with UV light with a wave length of 360 - 380 nm. The herein mentioned data for viscosity and shore hardness shall help you to choose the right product for your application (by the way, at 25°C water has a viscosity of approx. 1.0 mPa*s, motor oil at 25°C of approx. 100 mPa*s and honey - depending on the type - of approx. 4,000 - 10,000 mPa*s). As the resins have a limited shelf life they should be bought in quantities as needed and

always be stored in a dark and cool place. If stored properly our resins have a shelf life of at least 12 months from the production date, from the delivery from our stock of at least 9 months. To ease control you will find the best before date printed on each bottle. This ensures the use of only fresh products and gives you more application safety. For further information please also refer to the technical data sheet.



■ **VR-505AF**

Repair Resin ExtraPlus AF, extra thin, acid-free formulation, dropper bottle at 5 ml

■ **VR-515AF**

Repair Resin ExtraPlus AF, extra thin, acid-free formulation, dropper bottle at 15 ml

This repair resin is absolutely acid-free. Thereby it can also be used by persons who are sensitive to the acrylic acid contained in conventional resins. Commonly occurred discomfort like irritation of skin, eyes or the respiratory system, headache or even light sickness do no longer occur when using this acid-free resin.

Extra thin repair resin, excellent crack filler.

viscosity at 25°C: 10-20 mPa*s
shore hardness: D75



■ **VR-405AF**

Pit Filler Resin Extra AF, thin, acid-free formulation, dropper bottle at 5 ml

■ **VR-415AF**

Pit Filler Resin Extra AF, thin, acid-free formulation, dropper bottle at 15 ml

This pit filler resin is absolutely acid-free. Thereby it can also be used by persons who are sensitive to the acrylic acid contained in conventional resins. Commonly occurred discomfort like irritation of skin, eyes or the respiratory system, headache or even light sickness do no longer occur when using this acid-free resin.

More fluid pit filler, for a hard and shiny finish.

viscosity at 25°C: 90-100 mPa*s
shore hardness: D80



■ **VR-505**

Repair Resin ExtraPlus, extra thin, dropper bottle at 5 ml

■ **VR-515**

Repair Resin ExtraPlus, extra thin, dropper bottle at 15 ml

Extra thin repair resin, excellent crack filler.

viscosity at 25°C: 10-20 mPa*s
shore hardness: D75

■ **VR-305**

Repair Resin Extra, thin, dropper bottle at 5 ml

■ **VR-315**

Repair Resin Extra, thin, dropper bottle at 15 ml

Thin repair resin for all type of stone chips.

viscosity at 25°C: 20-30 mPa*s
shore hardness: D76



■ **VR-405**

Pit Filler Resin Extra, thin, dropper bottle at 5 ml

■ **VR-415**

Pit Filler Resin Extra, thin, dropper bottle at 15 ml

More fluid pit filler, for a hard and shiny finish.

viscosity at 25°C: 90-100 mPa*s
shore hardness: D80

■ **VR-205**

Pit Filler Resin Standard, dropper bottle at 5 ml

■ **VR-215**

Pit Filler Resin Standard, dropper bottle at 15 ml

Highly viscous pit filler for a hard finish.

viscosity at 25°C: 300 mPa*s
shore hardness: D78

■ **UV-528**

Equalizer Rock Star Roadie Windscreen Repair Kit

This system does not need a repair fixture. Instead it uses a pedestal that is bonded directly over the point of impact and that works as the resin chamber. Simple repair system for occasional use (e. g. for dealers of used cars).



Kit contains:

- 1 injectors (INJ-581)
- 1 connection hoses (H-538)
- 1 UV battery lamp (batteries included)
- 1 flow regulators
- 1 cure guard
- 1 carbide probe
- 20 pedestals (like P-536)
- 20 adhesive pads (like AS-537)
- 1 repair resin, extra thin (VR-505)
- 1 pit filler resin, thin (VR-405)
- 1 scraper with blade
- 20 mylar squares
- 1 Glass Repair Polish (SP-025)
- 1 instruction manual

■ **P-536**



Pedestal for UV-528 package at 25 pieces

The pedestals are self-adhesive and can be used several times.

Only the adhesive pad has to be exchanged after each use.

■ **AS-537**



Adhesive Pads for UV-528 package at 25 pieces

Use these adhesive pads to renew the pedestals P-536 and as an additional adjustment for repairs on strongly curved glasses.



■ **MR-300**

Mylar Squares, package at 20 pieces

Squares (approx. 25 x 25 mm) of transparent mylar foil to cover the repair area during UV irradiation.



■ **RK-10**

Scraper Blades 40 mm wide, package at 10 pieces

Top quality industrial blades with a thickness of 0.009 (=0.23 mm) and a solid metal back. Each blade has a single paper wrapping in the bag to prevent you from injuries.

■ **RK-10HD**

Heavy Duty Scraper Blades 40 mm wide, package at 10 pieces

Heavy Duty industrial blades with a thickness of 0.012 (=0.30 mm) and a solid metal back. Each blade has a single paper wrapping in the bag to prevent you from injuries.



■ **SP-025**

Glass Repair Polish, bottle at 25 ml

For polishing the point of impact after a repair. Apply polish on repaired area and polish by hand with a wipe or with a felt polishing wheel on the mini drill until the surface is smooth and shiny.



■ **FPS-005-N**

**Polishing Kit in 5 parts
for mini drills**



The small felt polishing heads are ideal for polishing the pit filler surface after a laminated glass repair. Also you are able to remove punctiform scratches, marks and staining from any glass surface.

Kit contains:

- 5 felt polishing wheels Ø 25 x 5 mm



■ MC-500

Inspection Mirror with suction cup

The mirror has a diameter of 50 mm. With the small PVC suction cup it can be fixed on any plain surface. Suction cup and mirror are connected with a ball joint. Sticked to the windscreen from inside it is the perfect helper for windscreen repairs.



■ MCM-500

Inspection Mirror with 3 time magnify & Vacuum cup

The **3 x magnifying** mirror has a diameter of 50 mm. With the small PVC suction cup it can be fixed on any plain surface. Suction cup and mirror are connected with a ball joint. Sticked to the windscreen from inside it is the perfect helper for windscreen repairs. Through the magnify optics the failure mode become detailed visible.



■ MCM-800



Inspection Mirror Ø 80 mm with 3 time magnify & Vacuum cup

The **3 x magnifying** mirror has a diameter of 80 mm. With the small PVC suction cup it can be fixed on any plain surface. Suction cup and mirror are connected with a ball joint. Sticked to the windscreen from inside it is the perfect helper for windscreen repairs. Through the magnify optics the failure mode become detailed visible.



■ MC-1000

Inspection Mirror with Vacuum

The mirror has a diameter of 100 mm, with the small PVC suction cup it can be fixed on any plain surface. Suction cup and mirror are connected fixed but sideways left and right moveable. Sticked to the windscreen from inside direct over the damaged spot it is the perfect helper for windscreen repairs. Trough the large wide you catch clearly more light whereby you get a much clearer picture from the damaged spot.



■ **CP-5040**

Carbide Probe

Probe with carbide tip to clean the impact point and to remove loose glass particles before repairing a stone chip.

Total length: 150 mm



■ **CRK-075**

Rescue Tool

With this Rescue Tool you can easily escape from a vehicle in case of an emergency. The 2-in-1 tool includes a window breaker for side and rear windows (ESG), as well as a seatbelt cutter.

Additionally this tool can be used as a cracker to simulate stone chip damages on windscreens.



■ **CRK-109**

Cracker

This small cracker is appropriate to easen repairings of stone chips by widening them slightly. Therefore the resin can enter better, respectively the air can escape easier. Handling should be trained on an old windscreen first.

Total length: 110 mm



■ **CRK-150**

Auto Center Punch

This Center Punch is a perfect tool to simulate stone chips especial crack's and star's into the windscreen.(Demonstration/Training) Into the lowest position it is also usable to open stone chips for a better enter of the resin and escape the air. This handling should be trained on an old windscreen first.

Total length: 150 mm

■ **SSK-790**

Bull's Eye Maker



The bull's eye maker is used to create stone chips on an old windscreen. By that, repairing technique can be trained in a test environment instead on your clients windscreen!



■ **WSR-150-P**

Poster „Steinschlagschaden?“ in size DIN A1 (59.4 x 84.1 cm)

Poster DIN A1 size that shows some typical stone chips. Placed in your sales room, it will draw your clients attention on it and makes an easy start for a sales conversation about stone chip repairing.

Sorry - actually only available in German language!

■ **WZA-4022**

Tool Tray made of rigid foam



Everything needed for a windscreen repair will fit into this tool tray. This way you will always have any small parts ready to hand and safely stored at your workplace.

The rigid foam offers a soft surface that will not scratch the paint and is non-skid so that the tray will safely stay on the hood.



outside dimensions (approx.): 47 x 30 x 5.5 cm
storage space (approx.): 40 x 22 x 4.0 cm



■ **SML-040**

Pocket Microscope 40x with LED lamp



Pocket microscope made of plastic with LED lamp and fortyfold magnification. Auxiliary tool for the repair and examination of scratches and stone damages on windcreens. For the LED lamp two batteries size AA are needed (not included).

■ **BA-MIGNON** Alkaline Battery size AA



■ **SMK-025**

Pen Microscope 25x



Pocket microscope made of aluminium and plastic with twentyfivefold magnification. Auxiliary tool for the repair and examination of scratches and stone damages on windcreens.



■ **SL-015**

Dome Magnifier 15x



Simple dome magnifier made of plastic with a transparent base. Nice tool for the repair and examination of scratches and stone damages on windcreens (fifteenfold magnification).

■ **AM-361**



Cordless Mini Drill 3,6 V with charging unit, collet set and polishing set

- precision tool for drilling stone chips
- also suitable for grinding and polishing
- handy and powerful
- gradational adjustable from 5,000 - 18,000 r.p.m.
- 4 collets for the use of different tools
- integrated 3,6V Li-Ion battery pack
- tool weight 0.235 kg
- charging cable with interchangeable plugs (EU, GB, US, AUS)

■ **AM-360-FPS**

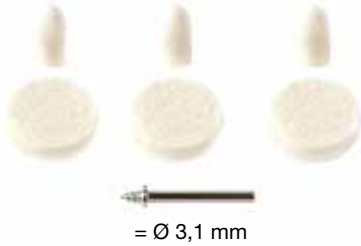

Polishing Kit, in 6 parts for mini drill

Various felt polishing heads to gloss the surface of windscreen repairs.

■ **AM-361-1**



Collets Kit, in 3 parts (for AM-361) suitable for all mini drills with chuck of Ø 4.2 mm

Suitable for all mini drills with a 4.2 mm chuck.

The collets suit for tools with a shaft diameter of 1.6 mm, 2.4 mm and 3.2 mm.

■ **AM-361-LG**



Charger 3,6 V for AM-361 (Li-ion)

technical data:

- input: 110-230V/50Hz AC
- output: 12V/500mA DC
- with interchangeable plugs (EU, GB, USA, AUS)

■ FPS-10



Polishing Kit, in 10 parts for mini drill

The small felt polishing heads are ideal for polishing the pit filler surface after a laminated glass repair. Also you are able to remove punctiform scratches, marks and staining from any glass surface.

■ SPS-012



Grinding and Polishing Kit in 12 parts for mini drills

A kit for the mini drill that complies with the requirements of car glass glaziers. Grinding adaptors to remove little corrosion spots and polishing adaptors to polish stone chip reparings.

Scope of delivery as shown.

■ DRB-140



Aluminium Bridge

With the aluminium bridge a constantly and controlled counter pressure from the inside of the windshield can be generated. Thereby the repair result e.g. of longer cracks, can be influenced very positively. A highly expedient add-on for each windshield repair kit. The handy bridge is also suitable for fixing freshly bonded mirror plates or sensor units.

■ MRH-055



Installation/Repair Hammer

Thanks to its two-sided head (1 x rubber cap, 1 x metal cap) this small and very handy tool can be used for various applications. Total length: approx. 175 mm / Total weight: approx. 55 g



■ **KMB-085** Carbide Drill Bits, tapered Ø 0.8 mm package at 10 pieces

■ **KMB-085-1** Carbide Drill Bits, tapered Ø 0.8 mm single

technical data:

- shaft-Ø: 1.6 mm
- length of shaft: 12.0 mm
- total length: 19.0 mm



■ **KMB-105** Carbide Drill Bits, tapered Ø 1.0 mm package at 10 pieces

■ **KMB-105-1** Carbide Drill Bits, tapered Ø 1.0 mm single

technical data:

- shaft-Ø: 1.6 mm
- length of shaft: 12.0 mm
- total length: 19.0 mm



■ **KMC-085** Carbide Drill Bits, tapered Ø 0.8 mm, rounded tip, package of 10 pieces

■ **KMC-085-1** Carbide Drill Bits, tapered Ø 0.8 mm, rounded tip, single

technical data:

- shaft-Ø: 1.6 mm
- length of shaft: 12.0 mm
- total length: 19.0 mm



■ **KMC-105** Carbide Drill Bits, tapered Ø 1.0 mm, rounded tip, package of 10 pieces

■ **KMC-105-1** Carbide Drill Bits, tapered Ø 1.0 mm, rounded tip, single

technical data:

- shaft-Ø: 1.6 mm
- length of shaft: 12.0 mm
- total length: 19.0 mm



■ **KMK-110** Carbide Drill Bits, round Ø 0.8 mm package at 10 pieces

■ **KMK-110-1** Carbide Drill Bits, round Ø 0.8 mm single

technical data:

- shaft-Ø: 1.6 mm
- length of shaft: 12.0 mm
- total length: 19.0 mm



■ **KMK-120** Carbide Drill Bits, round Ø 1.0 mm package at 10 pieces

■ **KMK-120-1** Carbide Drill Bits, round Ø 1.0 mm single

technical data:

- shaft-Ø: 1.6 mm
- length of shaft: 12.0 mm
- total length: 19.0 mm



■ **UVB-150T**

UV Battery Lamp 4 W with Torch

Simple UV lamp with PVC suction cup to fix on the glass and integrated torch. Requires 4 batteries size AA (not included).

Wavelength 315-400 nm



■ **LR-150**

Replacement Tube 4W BLB for UVB-150 and UVB-150T

dimensions:

- length: 133 mm
- diameter: 16 mm
- wavelength 315-400 nm



■ **LRW-150**

Replacement Tube 4W BL for UVB-150 / UVB-150T

dimensions:

- length: 133 mm
- diameter: 16 mm
- wavelength 315-400 nm



■ **GKL-868**

UV Battery Lamp 4 W

- four small PVC suction cups for safe fixation on the glass
- 8 W high-power UV LED for very short curing times



■ **UVA-200-LED LED UV Lamp 2 W (12V)**
with Euro plug and 5 m connection cable



- two small PVC suction cups for safe fixation on the glass
- 2 W LED for very short curing times*
- NOTE: Not suitable for 24V vehicle voltage. Damages because of wrong vehicle voltage are not covered by warranty!

■ **UVN-200-LED LED UV Lamp 2 W (230V / 50 Hz)**
for power outlet/cigarette lighter



- two small PVC suction cups for safe fixation on the glass
- 2 W LED for very short curing times*

*Besides the UV radiation the real curing time also depends on the used resin. With this lamp all our resins cure in only 60 seconds.

■ **UVA-400-LED ProGlass UV LED Lamp 8 W (12V/24V/230V) with Euro plug and 5 m connection cable**



- Universal UV LED light for all type of vehicles
- two small PVC suction cups for safe fixation on the glass
- 8 W LED for very short curing times*

* Besides the UV radiation the real curing time also depends on the used resin. With this lamp all our resins cure in only 60 seconds.

■ **UVAA-170-LED ProGlass battery powered UV LED lamp 5V / 8W**



- 8 W high-power UV LED for very short curing times
- This cordless,handy and very efficient UV-Light is perfect for the mobile and stationary use.
- Two small PVC suction cups for safe fixation on the glass

* Besides the UV radiation the real curing time also depends on the used resin. With this lamp all our resins cure in only 30 seconds.

■ **SL-230V**



**Work Light 8W (230 V / 50 Hz)
with Euro plug and 5 m connection cable**

Robust work light with electronic ballast (with bright white fluorescent tube - no UV lamp!). With a rotary metal hook.



■ **FSL-450**

**Flexible Suction Mount with Work Light
450 mm long**

Kit contains:

- 1 flexible suction mount (item no. FSH-450)
- 1 work light 8W (item no. SL-230V)



■ **FSH-450**

**Flexible Suction Mount
450 mm long**

The suction mount enables you to easily and safely fix a work light on almost every flat surface on a vehicle. Thanks to the flexible arm the lamp can be adjusted easily. With this device you can for example perform windscreen repairs even in poorly lit places.

technical data:

- suction pad-Ø 120 mm
- flexible arm length: 38 cm
- suitable for lamp-Ø of approx. 25-30 mm



■ **SPF-050-D** **Windscreen Plaster, German package at 50 pieces**

■ **SPF-050-E** **Windscreen Plaster, English package at 50 pieces**

■ **SPF-050-F** **Windscreen Plaster, French package at 50 pieces**

The windscreen plaster is a cost-efficient give away. Many bigger companies in our business have been using it successfully for quite a long time.

Make sure to get your part of the windscreen repair business and hand out the windscreen plaster to as many as possible of your clients.



The front side is neutral and refers to the specialist mentioned at the back side. At the back side you can attach a printed address label or put your company stamp.



■ **SPF-050-IND** **Windscreen Plaster, designed individually**

Starting from 1.000 pieces we print your individually designed business card with windscreen plaster!

The front side of the business card (printed on 350g offset paper, size 85 x 55 mm) contains some general information about windscreen repair and a peelable windscreen plaster (Ø 34 mm) with your company name and phone number.

The reverse side can be designed completely to your wishes. If you want to include a company logo or if you already have an artwork (e.g. your business card), please send us these files in PDF format. If you provide printable PDF files from your graphic designer you can also individualize the front side. For this purpose please ask for our layout guidelines.



To offer you the best prices this product is produced in combination with orders from other customers. This means that we collect the orders and print them together periodically. Please check the scheduled dates on our website (under item SPF-050-IND). For bigger quantities or special designs we will be happy to submit you an individual quote.



GPF-250

■ GPF-250

ProGlass Glass Polish
bottle at 250 ml, liquid polishing compound

■ GP-1000

ProGlass Glass Polish
box at 1 kg polishing powder, to mix with water
(makes approx. 1,660 ml liquid polishing compound)

■ GP-5000

ProGlass Glass Polish
bucket at 5 kg polishing powder, to mix with water
(makes approx. 8,330 ml liquid polishing compound)

ProGlass glass polish, liquid or powder, is a high-quality grinding and polishing product, for surface finishing of glasses. The ingredients are the same used successfully in the glass industry to remove scratches and to polish glass surfaces.

For scratch removal we recommend to use a polishing machine or an orbital grinder.

Fine scratches, transport defects, traces from the suction cup lifter, coatings and resistant dirt can also be removed by hand. For that please use a clean cotton cloth, a lint-free tissue, a cloth to polish varnish or anything similar.

Features:

- reliable deep cleaner for the vehicle replacement glazing (**removes all oil, grease and silicone residues**)
- perfect pre-cleaner for thorough cleaning before applying a water repellent or to fully remove any previously applied coatings
- high-quality polishing agent to remove scratches on the glass surface (e.g. caused by windscreen wipers, ice scrapers, cleaning sponges or similar things)
- simple and safe application
- inoffensive to varnishes, plastics and rubber parts
- for hand and machine polishing



GP-1000



GP-5000



■ XP-050

QUIXX Scratch Remover
tube at 50 g, for acrylic and plexiglass

QUIXX is a low cost solution for scratched backlights, caravan windows, boat windows, motorcycle windscreens and helmet visors. Easy application by hand or with the machine - use the soft sponge to avoid holograms. Not applicable on polycarbonate!



■ **WPO-14-25E Fein Angle Polisher 230V / 1200 W**

- Ideal speed range with infinitely variable speed control for professional surface processing on vehicles.
- Maximum speed stability at any load over the full setting range thanks to mechanical gear reduction in conjunction with the FEIN high-power motor.

Kit contains:

- Fein Angle Polisher
- Support plate with Velcro attachment, Ø 125 mm
- Polishing sponge, orange, Ø 150 mm



■ **PSW-150 FEIN Polishing Sponge, white, Ø 150 mm with velcro black**

Fine-pored soft polishing sponge recommended for strongly curved glasses. Using it with our glass polish, please take into account that a new sponge absorbs a lot of polish. Only after reaching a certain saturation it will be effective.



■ **PSO-150 FEIN Polishing Sponge, orange, Ø 150 mm with velcro black**

Fine-pored hard polishing sponge for high stock removal rate. Using it with our glass polish, please take into account that a new sponge absorbs a lot of polish. Only after reaching a certain saturation it will be effective.



■ **PFW-075 Cling-fit Polishing Felt, hard, Ø 75 mm x 5 mm (white)**

■ **PFW-150 Cling-fit Polishing Felt, hard, Ø 150 mm x 5 mm (white)**



The polishing felt is especially good for faster removal of deeper scratches in a small area. Using it with our glass polish the felt will be saturated much faster than a sponge.



■ **FPS-128**

Felt Polishing Disc 100 x 28 mm

■ **FPS-142**

Felt Polishing Disc 100 x 42 mm

With this, through its density and purity, high-grade polishing wheel you are able to remove scratches, marks and staining from any glass surface.

We advise to use in combination with glass polish to achieve more positive results. The polishing wheel stands out due to a very low abrasion which results in a very long service life. To be used with an electrical or cordless drill (speed up to 3000 rpm).

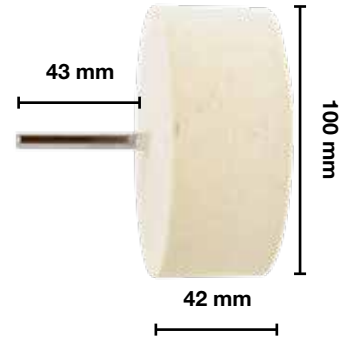
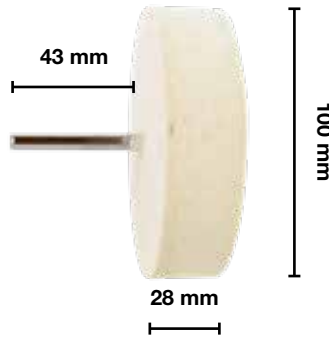

■ **SAW-360**



Scratch-A-Way, electric

This system does not need a repair fixture. Instead it uses a pedestal that is bonded directly over the point of impact and that works as the resin chamber. Simple repair system for occasionally use (e. g. for dealers of used cars).

Kit contains:

- 1 polishing machine, 230 V / 200 W, 7,000 - 13,000 rpm
- 3 fine polishing discs
- 1 marker
- 1 loupe, 30-fold magnified
- 1 leather wipe
- 1 sanding pad
- 2 metal disc
- 1 polishing paste fine/mittle/coarse(each)
- 1 instruction manual/USB
- 1 plastic case with foam lining

■ **SRS-93054**

Fine Polishing Disc Ø 50 mm (velcro) single

■ **SRS-93066**

Fine Polishing Disc Ø 50 mm (velcro) package at 20 pieces





- SAS-340
- SAS-340-B



Sehen Ihre Scheinwerfer so aus?

**schlechte Sicht bei Nacht - erhöhtes Sicherheitsrisiko
unansehnliche Optik - kein TÜV!!!**



Wir bieten eine günstige Lösung!

Mit dem ProGlass Scheinwerfer-Aufbereitungssystem werden die durch UV-Strahlung und Umwelteinflüsse vergilbten und ermatteten Scheinwerfergläser aus Kunststoff wieder wie neu!

- geeignet für alle Kunststoffgläser (konventionelle Streuscheibe und Klarglas-Design)
- erspart Ihnen den mehrere 100 € teuren Austausch der kompletten Scheinwerfer
- aufbereitete Scheinwerfer sind für mindestens 2 Jahre gegen die erneute Verwitterung der Kunststoffgläser geschützt

- **wieder optimale Sicht**
- **mehr Fahrsicherheit**
- **verbesserte Optik**
- **kostengünstige & schnelle Methode**



Headlight Restoration Kit Full Set in plastic case

Headlight Restoration Kit Starter Set without case

Plastic headlight lenses (polycarbonate) deteriorate with age and become yellow opaque. The brightness of the light is reduced and the risk of accidents during night driving is increased.

With this professional system for the restoration of weathered plastic headlight lenses, you can offer your customers an economical and ecological alternative rather than replace the whole headlight.

The system comes in a foam-lined plastic case, so that all components are properly maintained.

In addition to the parts and materials in the system, you only need a cordless drill (for example Item No.: ABSU-12C), tape (to protect the adjacent parts of the vehicle), a spray bottle with clean water and cleaning paper.

Features:

- suitable for all plastic headlight lenses (standard design and transparent)
- low cost of consumables for each headlight
- needed work-time for each headlight only about 30 minutes
- saves your customers the expensive replacement of the whole headlight
- lights treated with this system are protected against weathering of the plastic lenses for at least 2 years *
- profitable additional business for workshops, car glaziers, vehicle conditioners, dealers of used cars, etc.

* determined at specific long-term tests with different vehicles





SAS-340 Kit contains:

- 1 disc sanding pad 76.2 mm with adaptor for cordless drill SAT-762
- 1 interface pad soft, 76 mm STS-076
- 1 polishing pad abrasive, 80 mm SSG-080
- 1 polishing pad fine, 76 mm SSF-076
- 20 sanding disc grit 500 SLS-500 (pkg at 10)
- 20 sanding disc grit 800 SLS-800 (pkg at 10)
- 10 sanding disc grit 1500 SLS-1500 (pkg at 5)
- 6 sanding disc grit 3000 SLS-3000 (pkg at 5)
- 1 Polish, 235 ml SAP-235
- 1 Finish, 235 ml SAF-235
- 1 instruction manual, english
- 100 flyer DIN long (German) SAS-340-F (pkg. unit=100)
- 1 showroom poster DIN A1 (German) SAS-340-P
- 1 foam lined plastic case, approx. 34 x 27.5 x 8.3 cm

SAS-340-B Kit contains:

- 1 disc sanding pad 76.2 mm with adaptor for cordless drill SAT-762
- 1 interface pad soft, 76 mm STS-076
- 1 polishing pad abrasive, 80 mm SSG-080
- 1 polishing pad fine, 76 mm SSF-076
- 10 sanding disc grit 500 SLS-500 (pkg at 10)
- 10 sanding disc grit 800 SLS-800 (pkg at 10)
- 5 sanding disc grit 1500 SLS-1500 (pkg at 5)
- 5 sanding disc grit 3000 SLS-3000 (pkg at 5)
- 1 Polish, 235 ml SAP-235
- 1 Finish, 235 ml SAF-235
- 1 instruction manual, english
- 100 flyer DIN long (German) SAS-340-F (pkg. unit=100)

The starter set has a reduced scope of delivery, but besides that it uses the same high-quality components than the full set SAS-340.

**■ STS-076****Interface Pad soft, Ø 76 mm**

Soft interface pad as a compensating interface for the sanding discs SLS-500, SLS-800, SLS-1500 and SLS-3000. With hook and look fixture.

**■ SLS-500****Sanding Disc Grit 500, Ø 75mm,
package at 10 pieces****■ SLS-800****Sanding Disc Grit 800, Ø 75mm,
package at 10 pieces****■ SLS-1500****Sanding Disc Grit 1500, Ø 75mm,
package at 5 pieces**

Sanding discs with hook and look fastening for headlight restoration.

**■ SLS-3000****Sanding Disc Grit 3000, Ø 75mm,
package at 5 pieces**

Sanding discs with hook and look fastening for headlight restoration.



■ **SAP-235**

**Polish for the Headlight Restoration
bottle at 235 ml**

Specialized polishing compound for the headlight restoration.

No polish for car finishes - do not use on painted surfaces!

Does not contain siloxane!



■ **SSG-080**

**Polishing Pad Abrasive (orange)
Ø 80 mm**

Hard polishing pad with dense structure, for hook and look fastening.



■ **SAF-235**

**Finish for the headlight restoration
bottle at 235 ml**

Specialized polishing compound for the headlight restoration.

No polish for car finishes - do not use on painted surfaces!

Contains siloxane (4-12%).



■ **SSF-076**

**Polishing Pad Fine (grey)
Ø 76 mm**

Soft polishing pad with fine structure, for hook and look fastening.



■ **SAT-762**

**Disc Sanding Pad Ø 76.2 mm
with adaptor for cordless drill**

Disc sanding pad with hook and loop fixture for the headlight restoration system SAS-340 / SAS-340-B. With connection thread 5/16" x 24UNF and screwable adaptor for cordless drill.



■ **SAS-340-F**

**Flyer for Headlight Restoration
packing unit: 100 pieces**

The promotional flyer contains end-user information about the headlight restoration and shows a typical before-after situation. In this flyer it is explained in plain words why do headlights yellow over the years and what are the advantages of the restoration (flyer actually only available in German language).



■ **SAS-340-P**

**Poster „Do your headlights look like this?“
size DIN A1 (59.4 x 84.1 cm)**

Actually only available in German language.





- **CHM-108**
- **CHL-109**
- **CHX-110**

Cut-Resistant Protection Gloves, size M, per pair

Cut-Resistant Protection Gloves, size L, per pair

Cut-Resistant Protection Gloves, size XL, per pair

Pleasing to wear, made of finely knitted fabric with woven in glass fibre and grey PU coating at the inside. Outstanding cutting protection, breathable back side, perfect abrasion resistance, excellent sense of touch.

CE / EN 388 CAT II / 4 4 4 2 (cutting protection level 4!)



- **MHM-108**
- **MHL-109**
- **MHX-110**

Finely Knitted Gloves, non slip, size M, per pair

Finely Knitted Gloves, non slip, size L, per pair

Finely Knitted Gloves, non slip, size XL, per pair

Gloves pleasing to wear, made of finely knitted fabric - especially permeable to air and with optimum fit. Safe grip, due to the polyurethane coating at the inside. Excellent sense of touch combined with a good hand protection.

CE / EN 388 CAT II / 4 1 3 1



■ **LHM-108**

Winter Knitted Gloves, size M, per pair

■ **LHX-110**

Winter Knitted Gloves, size XL, per pair

The perfect winter gloves for the workshop and in the auto glass mobile service. Seamless knitted glove with foamed and waterproof crinkle latex coating. Soft and warm, especially used for outside work during the winter season. Thanks to the latex coating these gloves are really non-skid with a secure grip.

CE / EN 388 CAT II / 3 1 4 2 + EN 511 / X 4 X



■ **SHM-108**

Knitted Gloves, non-slip, size M, per pair

■ **SHL-109**

Knitted Gloves, non-slip, size L, per pair

■ **SHX-110**

Knitted Gloves, non-slip, size XL, per pair

High-quality cotton/nylon mix knitted gloves that are comfortable to wear and have an optimum fit. Safe grip, due to non slip dots at the palm. Good sense of touch combined with a high protection against cutting.

CE / EN 388 CAT II / 0 2 4 2

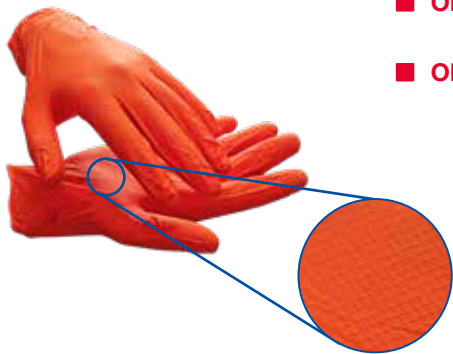
**■ ONG-050L**

GRIPSTER Nitrile Disposal Gloves, orange, powder-free
Size: L, package at 50 pieces

■ ONG-050XL

GRIPSTER Nitrile Disposal Gloves, orange, powder-free
Size: XL, package at 50 pieces

Sturdy and several times usable Nitrile glove. This is possible through a material thickness from 0,15mm at the outside hand up to 0,26 mm at the inside hand.

- Excellent characteristics at handling with resin, primer, oil, grease, cleaning and solvent
- Through his specially fish surface you get a perfect grip even in a wet situation

CE / EN 374

■ EHN-694

Nitrile Disposal Gloves, powder-free
package at 100 pieces

Nitrile has similar carrying properties than Latex or Vinyl. But it is also resistant against chemicals. Everybody who is doing glass repairs or working with solvents should wear these gloves to protect the skin.

CE / EN 374 / EN 455





■ **BNG-418**

Nitrile Disposal Gloves, black, powder-free
Size: L, package at 100 pieces

■ **BNL-820**

Nitrile Disposal Gloves, black, powder-free
Size: XL, package at 100 pieces

These gloves have textured fingertips for better handling of small items, are high chemical and puncture resistant, and contain no MBT or Latex. They have an unsurpassed comfort and have no offensive odor.

CE / EN 374 / EN 455



■ **EHV-500**

Vinyl Disposal Gloves, powdered,
package at 100 pieces

Vinyl is stretchable and tearproof similar to latex. Therefore it is a perfect solution for persons with latex allergy.

CE / EN 455



■ **EHL-652**

Latex Disposal Gloves, powder-free
package at 100 pieces

Powder-free gloves are particularly suitable for touching the glass edges without leaving traces. No negative impact on adhesion.

CE / EN 374 / EN 455

■ **EHL-140**

Latex Disposal Gloves, powdered package at 100 pieces

Latex gloves protect your hands against polyurethane, primer and other persistent dirt. At the same time they protect your skin against aggressive cleaning agents.

CE / EN 455



■ **SB-886**

Safety Goggles

Unbreakable goggles made of transparent polycarbonate (PC). The ear pieces can be adapted individually due to the very pliable material. The goggles are shaped in a style that will fit over the most spectacle frames.



■ **SBE-920**

Safety Goggles

Sporty clear safety glasses, UV protection 400, scratch-proof, anti-fog, PC 2 mm viewing glass, in length and inclination adjustable holder, nonslip, perfect fit, bulletproof until 45 m/s, usable for all mechanical risk, sport, leisure. Optimal at normal lighting conditions.



■ **MBM-PG**

Reusable makeshift mask

Mouth-nose mask with ProGlass print. Reusable makeshift mask made of polyester fabric (Ökotex certified) with sewn-in nose piece. Washable at 60 °C. One size with elastic elastic cord.



The image shows the interior of a car with grey seats and a dashboard. A dark blue workshop cover with a red border and the 'ProGlass' logo is draped over the passenger seat and the inner door panel. The cover is made of a heavy-duty material and is designed to protect the car's interior from damage during repairs.

ProGlass Workshop Covers

While working on a customer's vehicle it is not only important to perform a proper repair, but also to avoid secondary damages. Therefore the vehicle should be protected anytime from any unnecessary risk best possible.

Our workshop covers protect the vehicle's interior and exterior in an optimum way. The new Wing Protector covers doors and wings – thus exactly the area in which a technician could get in touch with the varnish – to protect this area particularly well. The non-skid Car Covers also prevent from scratching the varnish or the dashboard. At the same time they offer a safe depot for tools and small parts. The Seat Covers protect the vehicle's interior from soil and damage, depending on the model only the two front seats or the whole front passenger area.

All our workshop covers are made from high-quality components and sewn in manual production in Germany. The outcome of this is durable and hard-wearing products – made for the professional use. In the production we set a high value on accurately positioned and neatly processed seams. In all strained areas, like e. g. the practical hangers, we even use double seams.

This is really visible quality - for products that last for a long time.

■ **KFS-150**

ProGlass Wing Protector 150 x 50 cm

A workshop cover for wings and doors with very flexible mounting options. This unique cover is suitable for all magnetic and non-magnetic car bodies.

Thanks to the various mounting options this wing protector can be used on all different kind of cars! It can be fixed to the vehicle with the integrated magnetic tape, by hanging into the clearance between wing and hood or into the door window opening, with the cords at the upper corners to screws, holes or in door seals, with center cords and stopper at side mirrors.

Advantages:

- no risk of scratching the painting
- quick and easy handling thanks to the flexible mounting options
- professional appearance towards the customer

Properties:

- the fabric (Nylon 70D) is hard-wearing, persistent and water-repellent
- skidproof, cushioned reverse side (5 mm thick non-slip mat)
- magnetic tapes for safe mounting on steel bodies
- plug-in tongues for easy mounting to car body clearances
- cords for variable mounting to screws, holes or in door seals
- all materials are colour-fast and light-resistant
- the cover is washable by hand (please do not clean in a washing machine because of the magnetic tapes and the cords)
- high-quality manufacturing - made in Germany
- available with individual logo in small quantities



■ MHS-180

ProGlass Bonnet Protector 180 x 65 cm

A workshop cover for bonnets and rear lids with magnetic fixing.

The evenly rounded side of this cushioned cover protects the bonnet's edge as well as the neighbouring body area. Thanks to the integrated magnetic tapes the cover even stays in place when the bonnet is opened. By that the vehicle's body is protected in the best way and during the whole working process.

Advantages:

- no risk of scratching the painting
- quick and easy handling thanks to the integrated magnetic tapes
- professional appearance towards the customer

Properties:

- the fabric (Nylon 70D) is hard-wearing, persistent and water-repellent
- skidproof, cushioned reverse side (5 mm thick non-slip mat)
- magnetic tapes for safe mounting on steel bodies
- all materials are colour-fast and light-resistant
- the cover is washable by hand (please do not clean in a washing machine because of the magnetic tapes)
- high-quality manufacturing - made in Germany
- available with individual logo in small quantities





■ **ESS-075**

ProGlass Single Seat Cover

Seat cover for covering one front seat.

Advantages:

- no glass pieces or dirt on the seats and on scratch-sensitive surfaces
- less dirt means less time for cleaning = time saving
- professional appearance towards the customer

Properties:

- with practical hanger loop for clean storage when not in use
- the fabric (Nylon 70D) is hard-wearing, persistent and water-repellent
- the reverse side is skidproof thanks to a soft PVC coating
- all materials are colour-fast and light-resistant
- the cover is fully washable
- high-quality manufacturing - made in Germany
- available with individual logo in small quantities



Customized Covers

Starting from a quantity of only 10 pieces (assorted) we can offer all our workshop covers with your own logo print.

Please contact us for further details and we will provide you an individual quote adjusted to your needs!



■ FZS-120



ProGlass Car Cover 120 x 50 cm

Protective mat with a skidproof, cushioned reverse side for covering and protecting hoods, fenders or dashboards.

Advantages:

- no risk of scratching the painting (fender covers with magnets can easily cause small scratches and dents)
- quick and easy handling (no more time-consuming masking of hood and fender edges with tape)
- safe and practical place to deposit hand tools on a vehicle
- professional appearance towards the customer

Properties:

- with practical hanger loop for clean storage when not in use
- the fabric (Nylon 70D) is hard-wearing, persistent and water-repellent
- skidproof, cushioned reverse side (5 mm thick non-slip mat)
- all materials are colour-fast and light-resistant
- the cover is fully washable
- high-quality manufacturing - made in Germany
- available with individual logo in small quantities

■ FZS-80



ProGlass Car Cover 80 x 45 cm

Protective mat with a skidproof, cushioned reverse side for covering and protecting hoods, fenders or dashboards.

Advantages:

- no risk of scratching the painting (fender covers with magnets can easily cause small scratches and dents)
- quick and easy handling (no more time-consuming masking of hood and fender edges with tape)
- safe and practical place to deposit hand tools on a vehicle
- professional appearance towards the customer

Properties:

- with practical hanger loop for clean storage when not in use
- the fabric (Nylon 70D) is hard-wearing, persistent and water-repellent
- skidproof, cushioned reverse side (5 mm thick non-slip mat)
- all materials are colour-fast and light-resistant
- the cover is fully washable
- high-quality manufacturing - made in Germany
- available with individual logo in small quantities

■ **LSS-200**



Wheel and switch knob cover set

Wheel and switch knob cover set for covering and protecting wheel and knob

Advantages:

- no risk of dirt or damage
- less dirt means less time for cleaning = time saving
- professional appearance towards the customer

Properties:

- the fabric (Nylon) is hard-wearing, persistent and water-repellent
- all materials are colour-fast and light-resistant
- the cover is fully washable at 50°



■ **TSP-292**

Equalizer TightSpot Paint Protector set of 2 pieces

Sometime you have to park cars so close together that the open door could damage the next vehicle. When this happens you need a Set of TightSpots. They are made of dense foam rubber block and a vacuum cup that holds the block in the right position.

■ **KSM-4732**



Knee protection pad 470 x 320 x 35 mm

Knee protection pad made of EVA foam for articular and body gentle working on deep and inaccessible spots.

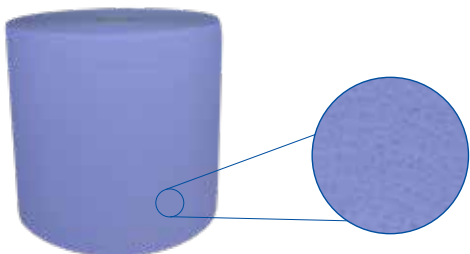

■ PBM-336**Paper Towel, 3-ply paper, blue, industrial quality
approx. 1000 towels 36 x 36 cm**

A top class three-ply paper for highest requirements. Specially soft and absorbent quality.

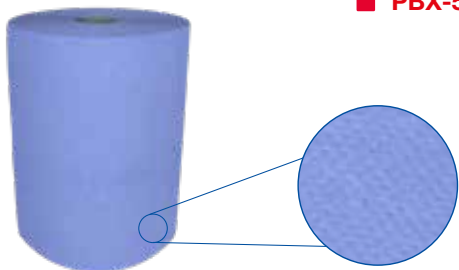
■ PBX-538**Paper Towel, 2-ply paper, blue, industrial quality
approx. 500 towels 38 x 38 cm**

Two-ply paper towel with glued plies for higher volume and better suction.

■ PWH-400**Paper Roll Holder, wall-mounted**

Wall mounted paper roll holder, made of blue lacquered steel pipe, galvanised steel sheet and plastic.

■ PBS-400**Paper Roll Holder, free-standing**

Free-standing paper roll holder, made of blue lacquered steel pipe, galvanised steel sheet and plastic.



■ **PBT-050**



Special-Cleaning Cloth 1-ply, turquoise

The cleaning cloth is optimally suitable for a free of residues and a lint free application.

- Lint free
- Tear-resistant
- Wet-strength
- Absorbent
- Washability
- Reusable

■ **MFT-3530**



**ProGlass Microfibre Cloth
warp knitted, 35 x 30 cm**

Microfibre cloth in looped knitting style (warp knitted) for fast cleaning of light and heavy structured surfaces, like e. g. dashboards and linings. The cloth is also suitable for the cleaning of glass surfaces. Washable up to 90°C.

■ **GTU-4040**



**Glass Cloth made of microfibre,
fine woven, 40 x 40 cm**

Smoothly knitted, small meshed cloth made of finest microfiber for effortless cleaning of all glass surfaces. Removes greasy contamination mostly with a single wipe. Washable up to 90°C.



■ XL-050



Quixx Varnish-Scratch-Remover

The Varnish Scratch Remover removes scratches, small scratches and traces of colour quickly, effectively and reliably from all shiny and metallic varnishes.



■ LPR-500

**ProGlass Universal Polish
bottle at 500 ml**

Universally applicable polishing compound to refresh a weathered car finish, to polish light scratches (good filling properties) or glue residues (e. g. after removing a vehicle labelling).

Long-lasting protection and care for every car finish.



■ SRS-500

**ProGlass Active Glass Cleaner
500 ml aerosol can**

Features:

- firmly active foam with excellent stain removing power
- dissolves and removes effortlessly all kind of dirt like insects, dust from the road, nicotine film, oil and grease from auto glasses, mirrors and painted surfaces
- also suitable for cleaning painted surfaces as well as rubber and plastic parts on vehicles
- high active ingredient, therefore more profitable than many other products on the market
- sprayhead system with narrow spray angle for easy reach into edges and corners
- silicone-free and gentle

Note:

Do not spray on hot surfaces. Not suitable for polycarbonate glass.

Only available in packing units of 12 pieces.



■ **SFL-1000**

**Spray Bottle with standard sprayer
capacity 1.0 litre**

Transparent plastic bottle with a capacity of 1,000 ml, for glass cleaner, soapy water and other non-corrosive liquids. Due to the adjustable plastic spray nozzle you will obtain any desired result from atomised spray to a strong jet of water. For transport the nozzle can be locked. Spray output: 1 ml \pm 0,1 ml



■ **SFM-1000**

**Spray Bottle with professional sprayer
capacity 1.0 litre**

Transparent plastic bottle with a capacity of 1,000 ml, for glass cleaner, soapy water and other non-corrosive liquids. Due to the adjustable plastic spray nozzle you will obtain any desired result from atomised spray to a strong jet of water. For transport the nozzle can be locked. The trigger head is extremely robust and long-lasting and has a big output. Spray output: 1.1 ml \pm 0,2 ml



■ **SFC-1000**



**Spray Bottle, professional quality, with FKM seal for use with
aggressive liquids, capacity 1.0 litre**

The spray bottle made of transparent plastic holds one liter of liquids and is also suitable for aggressive agents. The adjustable plastic nozzle delivers any desired spray pattern from finely atomized to a powerful jet and can also be turned off completely for transport. The professional spray head is extremely robust and durable and has a large output.

Spray capacity: 1.15 ml \pm 0.15 ml



■ **DPZ-1500**

**Compressed Air Sprayer, professional quality
capacity 1.5 litre**

White, transparent plastic container with a capacity of 1,500 ml, for glass cleaner, soapy water or other non-corrosive liquids. Put container under pressure, using the integrated manual pump. To spray, you only need to push the thumb lever. This type of spray bottle is perfect when a large amount of liquid is needed, e.g. to install window films. The handle is ergonomical shaped, comfortable handling even for frequent use. Due to the adjustable brazen spray nozzle you will obtain any desired result from atomised spray to a strong jet of water. For transport the nozzle can be locked.

■ **HRT-150**



ProGlass Hand Cleaning Towels dispensing bucket at 150 towels (approx. 28 x 28 cm)

The wet cleaning towels are perfect to remove even resistant dirt, on the way (in service vehicles, busses or lorries) but also at the work place where quick cleaning is required. Within seconds, fat, oil, grease, primer or auto glass adhesive will be removed. The towels have an agreeable odour and they are eudermic. Suitable to clean tools and all other colourfast and water compliant surfaces, such as many plastics, seat covers, roofliners, interior linings and varnished surfaces.

■ **HRT-072**



SCRUBS-IN-A-BUCKET Hand Cleaning Towels dispensing bucket at 72 towels (ca. 27 x 31 cm)

Mobile and very effective hand cleansing and tool cleaning system. Removes quickly, thoroughly and gently without water strongest dirt like grease, oil, glue, tar, wax, soot, paint, ink, sealant, polyurethane, etc. After cleaning your hands the towels retain enough cleaning power left for the effective cleaning of tools and equipment.

The towels are tintured with a special cleaning agent,

Napped side removes stubborn soils. Smooth side for gentle hand cleansing. The product is antibacterial, doesn't strip the skin's natural oils, and is biodegradable.

The single towels are micro-perforated and can be taken from the bucket easily. SCRUBS-IN-A-BUCKET belongs into every service vehicle and are especially useful for mobile auto glass jobs!



■ HRT-090



ProGlass Hand Cleaning Towels dispensing bucket at 150 towels (approx. 28 x 28 cm)

Mobile and very effective hand cleansing and tool cleaning system. Removes quickly, thoroughly and gently without water strongest dirt like grease, oil, glue, tar, wax, soot, paint, ink, sealant, polyurethane, etc. After cleaning your hands the towels retain enough cleaning power left for the effective cleaning of tools and equipment.

The towels are tintured with a special cleaning agent,

Napped side removes stubborn soils. Smooth side for gentle hand cleansing. The product is antibacterial, doesn't strip the skin's natural oils, and is biodegradable.

The single towels are micro-perforated and can be taken from the bucket easily. ProGlass Hand Cleaning Towels belong into every service vehicle and are especially useful for mobile auto glass jobs!



■ HRT-001



ProGlass Hand Cleaning Towel 22 x 20 cm singel

Mobile and very effective hand cleansing towel. Removes quickly, thoroughly and gently without water strongest dirt like grease, oil, glue, tar, wax, soot, paint, ink, sealant, polyurethane, etc. After cleaning your hands the towel retain enough cleaning power left for the effective cleaning of tools and equipment.

The towel are tintured with a special cleaning agent. Napped side removes stubborn soils. Smooth side for gentle hand cleansing. The product is antibacterial, doesn't strip the skin's natural oils, and is biodegradable.

The ProGlass Hand Cleaning Towel belongs into every vehicle and is especially useful for mobile jobs!

■ ANT-M18

Milwaukee Wet / Dry Vacuum Cleaner 18 Volt



- Built-in blower: provides 21 l/sec of air flow for maximum efficiency
- Wet/Dry using without filter exchange
- Stackable tool box design: for added portability and easier storage
- Flexible battery system: works with all Milwaukee® M18™ batteries (18V Cordless Caulking Gun)
- Supplied with washable filter, hose, crevice tool and utility nozzle
- Not usable for toxic and inflammable fluid
- HEPA rated 99.7 % high efficiency wet/dry filter: for fine dust collection
- **Attention!** Machine supplied without battery and charger.





■ FSD-025L-SET Fein Extractor Dustex 25 L with Accessory Set

Compact, powerful wet and dry dust extractor for connecting to power tools when working in the workshop and for assembly work, with accessory set FSD-25L-Z.

Technical data:

- Powerful turbine for 72 l/s volumetric flow and 253 mbar vacuum (240V)
- Low noise level of 67 dB (A).
- Large range thanks to 6 m power cable and 4 m suction hose.
- Large, 360° rotating castors for optimum manoeuvrability even in tight spaces.
- Tool collar with suction force regulation to set the suction power with ease.
- Auto start socket with switch-on delay to avoid power surges.
- Practical storage area with edge.
- Approval for dust class L.

■ FSD-025L Fein Extractor Dustex 25 L

Extractor with suction hose (length 4 m, Ø 35 mm), tool collar with suction force regulation, 1 Fleece filter bag and 1 Flat-fold filter cellulose.



■ FSD-025L-Z Fein Dustex 25 L Accessory Set

Kit contains:

- 2 suction pipes (metal)
- 1 combi nozzle with interchangeable inserts
- 1 groove nozzle
- 1 suction brush
- 1 elbow



■ FDB-025L Filter bag for DUSTEX 25 L, pack of 5 pieces

■ **OMB-0011**

**Ombrello Glass Treatment
Applicator for single use**



Ombrello glass treatment stands for perfect visibility even on worst weather conditions! One single application of the patented glass treatment on windscreen and front side windows, lasts for 20,000 km or 10 months. Visibility improves up to 34 %, which means a significant reduction of the reaction time in critical situations. Ombrello glass treatment also makes it easier to remove ice and any contamination.

Despite numerous praised products, based on the auspicious nanotechnology, the patented original still remains our favorite! None of the competitive products tested on our premises reached the same long-lasting hydrophobic effect like Ombrello!

But look and see the difference yourself!

■ **OMB-PC-200**

Ombrello PreCleaner



The use of Ombrello Professional PreCleaner substantially improves the adhesion of the Ombrello coating to the glass. Because the preparation of the glass surface is the essential step for the endurance of Ombrello Glass Treatment.

The specially developed PreCleaner is preparing the surface in an optimum way and, at the same time, offers a visible control about the cleanliness of the glass surface. The PreCleaner removes all residue from environmental influences (organic pollution from exhaust fumes, tire abrasion, etc.) as well as wax or other car maintenance products. The result is an improved endurance of the Ombrello coating.

Application

- Clean the glass area with a glass cleaner thoroughly from rough contamination.
- Shake the PreCleaner well before each use (approx. 2 min)!
- Pour a small quantity of PreCleaner on a soft cloth and wipe it over the glass surface (for optimum results, use an electric polisher with a cotton pad) until the liquid has build a milky, powdery slurry on the glass surface.
- Rinse with water and dry thoroughly.



- **OMB-012P** Ombrello Glass Treatment Professional Pack at 12 pieces in carton
- **OMB-024P** Ombrello Glass Treatment Professional Pack at 24 applicators (bulk packaged)
- **OMB-050P** Ombrello Glass Treatment Professional Pack at 50 applicators (bulk packaged)
- **OMB-100P** Ombrello Glass Treatment Professional Pack at 100 applicators (bulk packaged)
- **OMB-250P** Ombrello Glass Treatment Professional Pack at 250 applicators (bulk packaged)
- **OMB-500P** Ombrello Glass Treatment Professional Pack at 500 applicators (bulk packaged)

Especially for the professional application the Ombrello glass treatment is also available in a box at 12 pieces or, in bigger volumes (from 24 to 500 pieces), as bulk packaged applicators.

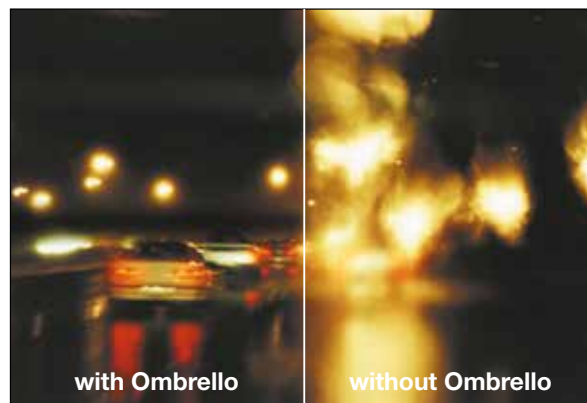



■ **OMB-6000** **Ombrello Display Poster
DIN A1 (84 x 59.4 cm)**

A large size, coloured advertising poster for your showroom or shop-window.

(only available in German)



■ **OMB-4000** **Ombrello Display for 6 blister packs OMB-0011
(delivered without content)**



■ **OMB-3333** **Ombrello Demonstration Jar**

A perfect sales promoter for your counter! This glass demonstrates the effect of Ombrello very clearly. The upper part is treated with Ombrello, the lower part is not. Glass contains a powder which turns into a brownish liquid when adding 50 ml water (best to use distilled water). Shaking the glass will show that the water runs off the upper part (treated with Ombrello) immediately whereas the lower part stays hazy for quite a long time.



■ **OMB-5000** **Ombrello Sticker 40 x 35 mm**

The small sticker, made of transparent foil, has a field to fill in the application date. Stick the label to the interior, bottom left corner of the windscreen and be sure, your client will not forget to have the Ombrello treatment renewed in due time.

Index by Item Numbers

Item No.	📖	Item No.	📖	Item No.	📖	Item No.	📖	Item No.	📖
2P1021	147	APP-5420-LG	138	CKM-021	224	DST-210	32	FIX-080	96
401	189	APP-5420-TZ	137	CMK-170	107	DST-410	33	FIX-080-P	96
1942	256	APP-5420-URS	137	CMM-018	225	DST-733	33	FKM-145	98
2496	256	APP-5620	137	CMU-099	224	DST-745	33	FPS-005-N	263
3319	185	AS-115-K	12	CP-5040	265	DST-757	33	FPS-10	269
4850	189	AS-537	262	CRK-075	265	DST-757-WSP	12	FPS-128	279
51847	51	ASB-001	147	CRK-109	265	DWR-120	88	FPS-142	279
51848	51	ASBB-10	109	CRK-150	265	EDS-150	26	FSB-102	59
51849	51	ASCM-12C	15	CS-696	78	EDS-150-0	26	FSB-103	59
AB-10	109	ASM-M12	16	CT-318	146	EES-804	61	FSC-120	99
AB-10S	109	ATG-5050	195	CZ-540	77	EES-808	61	FSC-150	99
AB-50S	109	ATC-100	52	DBP-1824-WSP	11	EES-812	61	FSC-300	99
ABB-50	109	ATV-2012	61	DBP-3316-WSP	11	EHB-186	62	FSD-025L	307
ABK-10	110	AV-418	146	DBP-3725	27	EHL-140	292	FSD-025L-SET	307
ABS-025	157	AV-435	147	DBP-4024-WSP	11	EHL-652	291	FSD-025L-Z	307
ABSU-12C	15	BA-MIGNON	267	DBP-4525	27	EHN-694	290	FSH-450	275
AC-325	146	BFE-1400	62	DBP-4530-SET	27	EHV-500	291	FSK-003	104
AC-625C	146	BHS-058	92	DBP-6030	27	ES-1406	61	FSK-150	98
ADR-300	25	BK-230	106	DBP-6030-S	27	ESB-1304-P	60	FSK-300	98
AEB-406	60	BK-315	106	DD-02	22	ESB-1308-P	60	FSL-213	104
AFSC-17	54	BMR-1488	78	DD-50	22	ESB-1312-P	60	FSL-216	104
AFSC-17	54	BN-308	86	DFS-100	29	ESS-075	296	FSL-219	104
AFSC-17-A	54	BN-326	86	DG-322	52	ESS-150	18	FSL-450	275
AGD-0505	150	BN-408	86	DGH-300	30	EWA-1702	87	FSS-213	104
AGQ-1265	149	BND-2882	86	DGL-200	31	EWS-620	232	FSS-216	104
AGR-1105	148	BNG-418	291	DGL-201	31	FB-072	57	FSS-219	104
AGT-1105	148	BNL-820	291	DGL-201S	31	FB-073	57	FTL-402	208
AGV-0906	149	BNZ-2685	86	DGL-201TS	18	FB-076	57	FTL-402-1	208
AGV-5449	150	BP-012-ABSU	15	DGS-301	30	FB-079	57	FTL-430	208
AHL-818	203	BP-180	141	DH-280	28	FB-081	57	FTL-430-1	208
AKP-075/L-01	143	BP-180-Z	144	DHL-300	30	FB-101	57	FWB-10	109
AKP-410-LG	143	BP-180-ZHP	144	DHS-360	80	FB-107	57	FZ-8326	256
AKP-420	142	BP-410P	143	DLH-511	85	FB-110	57	FZS-80	297
AKP-472	144	BP-472	144	DLL-806	51	FB-123	58	FZS-120	297
AKP-620	142	BP-5420	138	DLR-160	52	FB-157	58	GBZ-200	204
AKV-2515	151	BP-AFSC-17	54	DM-1094	153	FB-174	58	GBZ-225	204
ALS-185	211	CDZ-195	78	DNM-3050	168	FB-176	58	GC-130	204
AM-360-FPS	268	CE-119	76	DP001P00	28	FB-194	58	GCK-119	205
AM-361	268	CE-590	77	DP001P01	28	FB-207	58	GCM-130	205
AM-361-1	268	CE-607	77	DPZ-1500	303	FB-208	58	GCO-170S	205
AM-361-LG	268	CE-657	76	DR-475	257	FB-209	58	GH-701	90
AMM-880	96	CE-749	79	DR-950	257	FB-210	59	GH-738	203
ANT-M18	306	CEG-148	76	DRB-140	269	FB-211	59	GH-749	203
AP-25	154	CEG-1410	76	DRO-116	247	FB-212	59	GH-753	203
AP-100	154	CEK-180	80	DRV-500	247	FB-217	59	GHK-140	202
AP-100-B	154	CEK-215	80	DSA-125-1	238	FBH-190	13	GHK-280	202
AP-2500	154	CES-125	77	DSF-075	13	FDB-025L	307	GHK-560	210
APL-25	154	CES-250	78	DSP-120	206	FDS-700	155	GHS-140	202
APL-100	154	CHL-109	288	DSP-200	206	FEC-417	55	GHS-280	202
APL-100-B	154	CHM-108	288	DSP-400	206	FEC-417Q	55	GKL-868	272
APL-2500	154	CHX-110	288	DSP-800	206	FEC-417Q-A	56	GMK-300	184
APM-100-B	153	CK-2	112	DSP-1000	206	FEC-417Q-B	56	GP-1000	277
APP-5420	136	CKB-2	112	DSS-704	25	FGR-440	210	GP-5000	277
APP-5420-BA	138	CKM-007	225	DST-125	32	FGS-140	103	GPF-250	277

Index by Item Numbers (continuation)

Item No.	Item No.	Item No.	Item No.	Item No.	Item No.	Item No.	Item No.		
GPL-154	117	IND-601756	222	KPL-192C	123	KTO-230	179	MHF-510	210
GPL-154-1	117	IND-601796	220	KPL-192C-1	123	KTP-502K	183	MHK-069	79
GPL-166	117	IND-602030	221	KPL-193	123	L-2	110	MHL-109	288
GPL-166-1	117	IND-602060	221	KPL-193-1	123	LB-10	110	MHM-108	288
GPL-168	118	IND-603070	223	KPL-197	123	LB-300	95	MHP-139	179
GPL-168-1	118	IND-603080	223	KPL-197-1	123	LBB-10	110	MHS-068	79
GPL-190	118	IND-607703	222	KPM-3752	126	LBB-50	110	MHS-180	295
GPL-190-1	118	IND-611071	222	KPM-3752-1	126	LEC-175F	82	MHX-110	288
GPL-191	118	IND-611074	222	KPM-4151	126	LEC-175FL	82	MK-081	182
GPL-191-1	118	INJ-007-DI	259	KPM-4151-1	126	LEC-175FV	82	ML-101	156
GPL-192	118	INJ-M14-F	259	KPM-4169	126	LEC-175FZ	82	MLW-455	221
GPL-192-1	118	INJ-M14-KIT	259	KPM-4169-1	126	LEC-175G	83	MR-300	263
GPL-192C	119	ISH-691	84	KPM-4464	126	LEC-175GU	83	MRH-055	269
GPL-192C-1	119	IWH-692	84	KPM-4464-1	126	LEC-175GV	83	MS-6	103
GPL-194	119	JP-135	241	KPM-5010	127	LEC-SET1	82	MS-180	84
GPL-194-1	119	JP-140	241	KPM-5010-1	127	LEC-SET2	83	MS-180-WSP	12
GPZ-225	90	KA-539	181	KPM-6260	127	LED-LIGHT	208	MS-181	84
GS-120	102	KB-1228	151	KPM-6260-1	127	LEM-400	168	MS-205	83
GS-380	102	KBA-4915-12	180	KPM-7474	127	LH-230	85	MSF-010	247
GT-3516	242	KBA-4915-50	180	KPM-7474-1	127	LHK-160	80	MSK-356	209
GTG-5050	195	KFB-230	152	KPM-7488	128	LHM-108	289	MSL-265	85
GTU-4040	301	KFP-050	152	KPM-7488-1	128	LHX-110	289	MSP-2030	92
GY-025967	173	KFS-150	294	KPM-74132	127	LM-460	106	MT-1	109
GY-026971	174	KM-130	207	KPM-74132-1	127	LM-610	106	MTB-10B	109
GY-027510	173	KM-140	207	KPM-80164	128	LPR-500	302	MTG-5050	194
GY-029415	174	KM-150	207	KPM-80164-1	128	LR-150	272	MTP-3850	194
H-1	111	KM-9527	207	KPR-188	124	LRW-150	272	NTC-400	108
HB-5	111	KMB-085	270	KPR-188-1	124	LSK-140	187	NWS-1080	233
HBB-5B	111	KMB-085-1	270	KPR-191	124	LSL-030	186	OC-20M	53
HBS-027	81	KMB-105	270	KPR-191-1	124	LSOL-10	110	OCC-200E	164
HLK-012	94	KMB-105-1	270	KPR-194	124	LSS-085	186	OCC-300B	161
HOB-1	111	KMC-085	270	KPR-194-1	124	LSS-200	298	OCC-300-E	163
HOK-1	111	KMC-085-1	270	KPR-199	124	LT-415	201	OCC-300P	161
HP-1002	186	KMC-105	270	KPR-199-1	124	LT-415-1	201	OCC-DT01	165
HRS-100	237	KMC-105-1	270	KRS-1588	196	LT-750	201	OCC-DT02	165
HRT-001	305	KMK-110	271	KS-125	157	LT-750-1	201	OCC-DT03	165
HRT-072	304	KMK-110-1	271	KSC-019	212	MAC-1125	29	OCC-DT04	165
HRT-090	305	KMK-120	271	KSC-025	212	MB-743	91	OCC-DT05	166
HRT-150	304	KMK-120-1	271	KSK-050	183	MB-744	91	OCC-DT06	166
HWA-2636	87	KPA-250	125	KSK-4510	212	MBM-PG	292	OCC-DT07	166
HWS-680	232	KPL-154	121	KSK-29190	212	MBR-600	91	OCC-ET01	166
HWS-760	232	KPL-154-1	121	KSM-4732	298	MC-500	264	OCC-KLL	168
IND-0609	220	KPL-166	121	KSP-1580-12	180	MC-1000	264	OCC-RSS	163
IND-601099	220	KPL-166-1	121	KSP-1580-100	180	MCA-265	189	OCC-SLR	164
IND-601201	220	KPL-185	122	KSP-1580S-12	180	MCM-500	264	OCC-ST01	167
IND-601703	222	KPL-185-1	122	KSP-1580S-100	180	MCM-800	264	OCC-ST02	167
IND-601704	222	KPL-189	122	KSP-15104-12	180	MD-085	183	OCC-ST03	167
IND-601720	222	KPL-189-1	122	KSP-15104-100	180	MD-085-P	183	OCT-400B	162
IND-601721	222	KPL-189B	122	KSP-15105V-10	181	MEH-234	62	OCT-400-E	163
IND-601723	222	KPL-189B-1	122	KSP-15110D-10	181	MESSER-C	108	OCT-400P	162
IND-601725	222	KPL-190	122	KSR-5025	196	MFT-3530	301	OCT-3040G	163
IND-601727	222	KPL-190-1	122	KSX-200	196	MH-120	210	OCT-ST01	167
IND-601730	222	KPL-192	123	KSZ-163	182	MH-140-WSP	12	OCT-ST02	168
IND-601734	222	KPL-192-1	123	KSZ-306	182	MHD-110	79	OD-20M	53

Index by Item Numbers (continuation)

Item No.	Item No.	Item No.	Item No.	Item No.	Item No.	Item No.	Item No.		
OK-50	50	PMS-3000	198	SC-316E	101	SL-350-C	130	SWA-2316	89
OK-51	50	PRH-380	218	SC-318	100	SL-350-ZM1	131	SWS-580	233
OK-52	50	PRS-118	153	SC-320	100	SL-350-ZS1	131	SWS-580-01	233
OK-53	50	PSG-001	119	SC-320E	101	SL-350-ZV1	131	SWW-880	234
OK-54	50	PSG-004Q	120	SCA-316	100	SL-350-ZV2	131	TAB-0910	193
OK-55	50	PSG-012Q	120	SCE-007	100	SLK-17080	223	TAB-1210	193
OK-56	50	PSG-MD10	119	SCE-012	100	SLK-235130	223	TAB-1910	193
OK-57	50	PSG-MD10-K	120	SCR-006	100	SLK-S-9050	223	TAB-2510	193
OL-40	108	PSH-120-1	236	SCR-012	100	SLK-S-17080	223	TAB-5005	193
OM-520	48	PSL-150-1	236	SD-02	21	SLL-100	209	TAC-1210	192
OM-610	48	PSO-150	278	SD-22	21	SLN-102	200	TAC-1910	192
OMB-0011	308	PSW-150	278	SD-44	21	SLN-102-01	200	TAC-2510	192
OMB-012P	309	PT-321	52	SDK-202	25	SLP-101	200	TAC-5005	192
OMB-024P	309	PWH-400	300	SDM-421	92	SLP-101-01	200	TAT-1910	192
OMB-050P	309	QT-5050	225	SFC-1000	303	SLS-500	284	TB-3006	196
OMB-100P	309	RAP-F22	19	SFE-329	62	SLS-800	284	TB-3010	196
OMB-250P	309	RF-050	255	SFL-1000	303	SLS-1500	284	TF-0910	193
OMB-500P	309	RFM-683	85	SFM-1000	303	SLS-3000	284	TF-1210	193
OMB-3333	310	RH-727	213	SFP-10	184	SMK-025	267	TF-1910	193
OMB-4000	310	RHR-410	213	SFP-100	184	SML-040	267	TF-2510	193
OMB-5000	310	RK-10	263	SFS-1550	197	SMQ-525	36	THH-540	94
OMB-6000	310	RK-10HD	263	SFT-1025	197	SOL-189	115	THH-540-G	94
OMB-PC-200	308	RK-100A	102	SFT-1525	197	SOL-192A	115	TK-10	107
OMS-520	49	RK-100B	102	SFT-2025	197	SOL-192C	115	TKS-100	107
OMS-610	49	RK-100HD	102	SFT-2525	197	SOL-192D	115	TM-600	145
ONG-050L	290	RK-8905	103	SFT-3025	197	SOL-193A	116	TMA-2012	191
ONG-050XL	290	RKK-10	103	SGM-05	235	SOL-193B	116	TMB-5555-3	190
OP-20F	53	RKS-594	182	SGM-09	235	SOR-199	114	TMB-5555-P	190
OP-20M	53	RMP-416	91	SGS-05	234	SP-0010	177	TMB-6655-3	190
OS-20F	53	RMP-416-1	91	SGS-09	234	SP-025	263	TMB-6655-P	190
P6	10	RMS-105	185	SHE-070	238	SP-1010	177	TMC-5545-3	190
P8	10	RS-2030	256	SHG-200	242	SPF-050-D	276	TMC-5545-P	190
P-536	262	RSL-330	120	SHL-109	289	SPF-050-E	276	TMC-6645-3	190
PBA-1827	141	RSS-0819	93	SHM-108	289	SPF-050-F	276	TMC-6645-P	190
PBM-336	300	RT-560	214	SHP-150	239	SPF-050-IND	276	TM-TN-0022	143
PBS-400	300	RTD-509	242	SHP-150-1	239	SPS-012	269	TN-310	145
PBT-050	301	RW-201	226	SHP-200-1	240	SPZ-160	30	TN-600	145
PBX-538	300	RW-205	227	SHP-230-1	240	SRB-09	101	TO-1437	152
PCG-180	140	RW-217	228	SHU-3237	255	SRB-12	101	TO-1437-100	152
PCG-180-F	140	RW-239	229	SHV-125-1	241	SRB-17	101	TPB-1910	187
PCG-180-KF	139	SAB-10	109	SHX-110	289	SRS-500	302	TPB-1925	187
PCG-180-KFT	139	SAF-235	285	SK-113	104	SRS-93054	280	TPC-1910	192
PCG-180-URS	141	SAP-235	285	SK-116	104	SRS-93066	280	TPO-3833	194
PES-0165	198	SAS-340	282	SK-119	104	SRW-006	235	TPO-7691	194
PES-2500	198	SAS-340-B	282	SK-1060B	176	SSF-076	285	TS-135	11
PFK-050	133	SAS-340-F	286	SK-1060K	176	SSG-080	285	TSG-400	17
PFN-300	133	SAS-340-P	286	SKA-502	116	SSH-290	95	TSG-401	17
PFW-075	278	SAT-762	286	SKA-502M	116	SSH-290	156	TSP-292	298
PFW-150	278	SAW-360	280	SKS-003	105	SSK-790	266	TSP-2550	211
PHL-115-1	237	SB-886	292	SKS-1060B	178	STG-3850	195	TSP-5050	211
PHX-150-1	237	SBE-920	292	SKS-1060K	178	STG-5050	195	TVB-0333	186
PL-140	209	SC-313	100	SL-015	267	STS-039	93	TWH-500	31
PLE-160	208	SC-313E	101	SL-230V	275	STS-076	284	TX-APP06.5-OBDD	169
PML-145-1	155	SC-316	100	SL-300-S	132	SVR-2	108	TX-APP23.1-OBDD	170

Index by Item Numbers (continuation)

Item No.	Item No.	Item No.	Item No.	Item No.	Item No.				
TX-APT06.6-OB	171	UW-3001RK	37	WK2	67	WK28L	70	WSR-800K-BO	246
TX-APT09.1-OB	172	UW-3007	37	WK2-S	67	WK28M	70	WSR-800-PH	246
TX-P1291B	171	UW-3055-K	39	WK3	68	WK28RM	70	WSR-800-PHS	246
TX-P12926	169	UW-5001-P	41	WK3-S	68	WK28S	70	WSR-800W	245
TX-P13010	172	UW-5002-P	41	WK4	68	WK28XL	70	WSW-800	245
TX-P13020	170	UW-5004-P	41	WK4R-S	69	WKB-300	218	WZA-4022	266
UAZ-1950	90	UW-5500	45	WK4-S	68	WKB-400	218	WZK-7749-R	230
UCC-320	105	UW-5501	45	WK4Z	68	WKBTR15-BX	66	WZT-5836	230
UCH-319	105	UW-5502	45	WK4ZR-S	69	WKCLS-BX	64	XKD-02	24
UCL-322	105	UW-5503	45	WK4Z-S	68	WK-KEY	74	XKD-22	24
UCS-321	105	UW-6991	41	WK4ZVR-S	69	WKSTR-BX	64	XKD-44	24
ULF-481	214	UW-6992	41	WK4ZV-S	69	WKTDM-BX	65	XL-2	110
ULR-120	29	UW-6994	41	WK5	68	WKTEC-BX	65	XL-050	302
ULR-150	29	UW-7001-P	42	WK5-S	68	WPO-14-25E	278	XN-96	9
UMS-437	107	UW-7002-P	42	WK5ZR-S	69	WPRO6-3IN1-D	134	XP-050	277
UP-100B	188	UW-7004-P	42	WK5Z-S	69	WPRO6-INS4	134	XUB-05	107
UP-105B	188	UWE-3	43	WK6-40	73	WRD-4RD	14	ZAW-090	89
UP-107B	188	UWG-3	43	WK6-40N	73	WRD-DPS	14	ZFK-3007	37
UP-200	188	UWS-6	43	WK6-L	73	WRD-LD	13	ZGL-195	36
USS-190	46	VIP-1138	19	WK6-LN	73	WRD-RK	39	ZK-35	39
UTO-539	181	VKD-02	23	WK6-M	73	WRD-SKB	99	ZK-45	39
UV-528	262	VKD-22	23	WK6-MN	73	WROBK-300K	9	ZK-0119	46
UVA-200-LED	273	VKD-44	23	WK6-MXN	72	WS-782	32	ZK-0119-P	46
UVA-400-LED	274	VKS-202	25	WK6-N-SET	72	WS-782P	32	ZK-0125	46
UVAA-170-LED	274	VR-205	261	WK6-S	73	WSA-600-0	217	ZK-0125-P	46
UVB-150T	272	VR-215	261	WK6-SET	72	WSA-620	216	ZK-0138	46
UVN-200-LED	273	VR-305	261	WK6-SN	73	WSH-7050	218	ZK-0138-P	46
UVN-806	248	VR-315	261	WK7	74	WSK-31	219	ZKS-110	38
UW-51C1	42	VR-405	261	WK7L	74	WSL-180	209	ZKS-150	45
UW-51C1-P	42	VR-405AF	260	WK10HD	66	WSP-003K	7	ZKS-180	45
UW-51C2	42	VR-415	257	WK11PP	70	WSP-004K	8	ZMK-110	38
UW-51C2-P	42	VR-415	261	WK16LR	71	WSR-100	258	ZML-395	38
UW-51C4	42	VR-415AF	260	WK17-4	71	WSR-100-1	259	ZMQ-500	36
UW-51C4-P	42	VR-505	261	WK17-6	71	WSR-100-A	258	ZMS-382	38
UW-109	40	VR-505AF	260	WK18Z	71	WSR-150-1N	254	ZMX-400	36
UW-119	40	VR-515	257	WK18ZS	71	WSR-150-2N	254		
UW-125	40	VR-515	261	WK19L	71	WSR-150-3	255		
UW-138	40	VR-515AF	260	WK19L-S	71	WSR-150-5	255		
UW-519	41	VRS-1000	177	WK19Z	71	WSR-150-6N	254		
UW-525	41	VSR-73E	26	WK19ZS	71	WSR-150-A	252		
UW-538	41	W-1414	13	WK24	68	WSR-150-N	252		
UW-550	44	WAB-150	88	WK24R-S	69	WSR-150-P	253		
UW-565	44	WAB-909	218	WK24-S	68	WSR-150-P	266		
UW-719	42	WAF-1535	88	WK24Z	68	WSR-300	250		
UW-725	42	WAN-3650	89	WK24ZR-S	69	WSR-300-1	250		
UW-738	42	WAS-700	87	WK24Z-S	68	WSR-300-3	255		
UW-1000-P	40	WAS-1630	88	WK24ZV	69	WSR-800	244		
UW-1001-P	40	WAV-899	89	WK24ZVR-S	69	WSR-800-1	248		
UW-1002-P	40	WAZ-919	90	WK24ZV-S	69	WSR-800-3	248		
UW-1004-P	40	WH-440	221	WK27L	70	WSR-800-4	249		
UW-1012	44	WK1	67	WK27M	70	WSR-800-5	249		
UW-1022	44	WK1-S	67	WK27RM	70	WSR-800-6	249		
UW-3001	37	WK1-X	67	WK27S	70	WSR-800-7	246		
UW-3001	37	WK1-ZX	67	WK27XL	70	WSR-800K	244		

Room for Your Notes

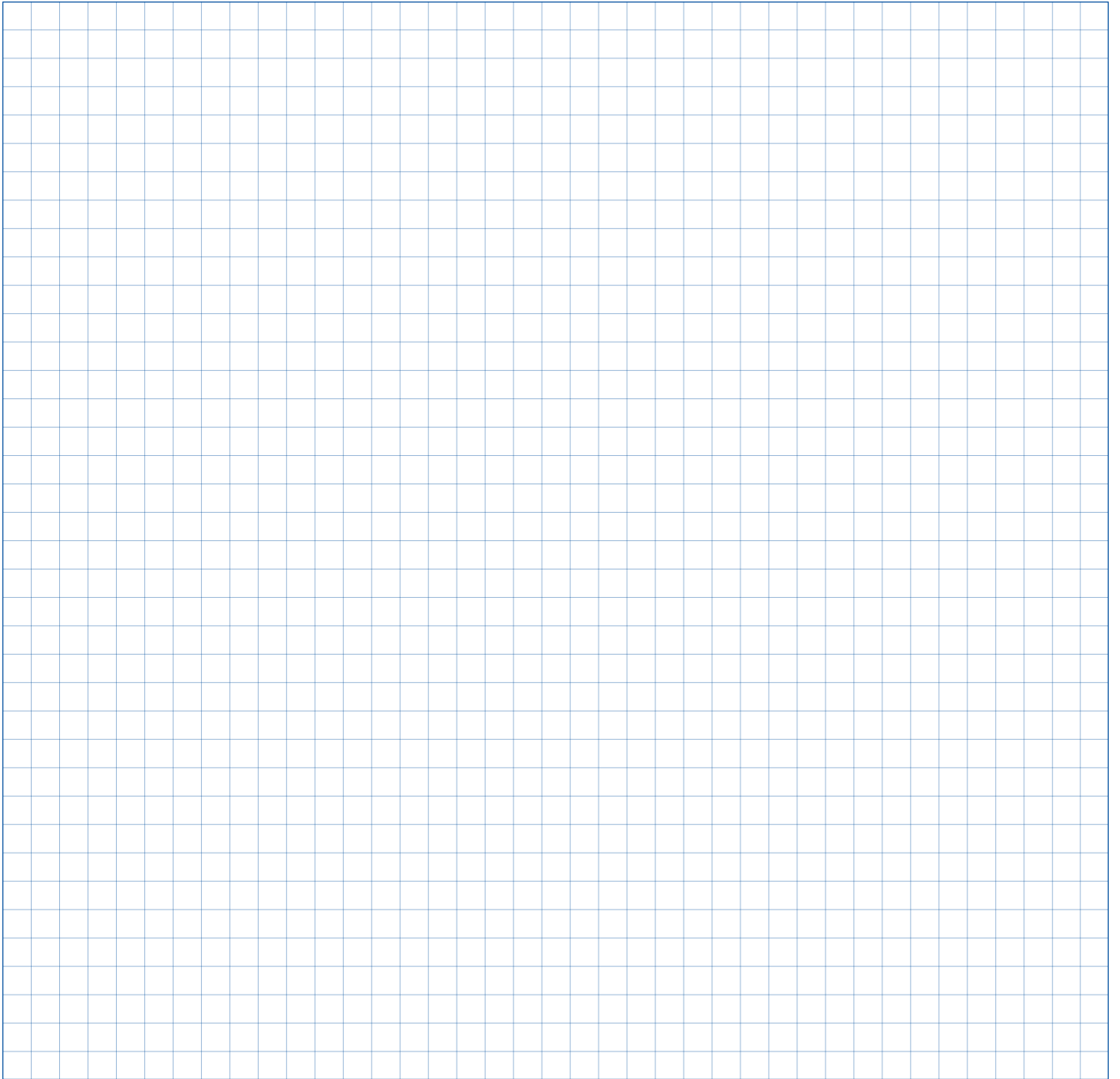

General Terms And Conditions

1. Conclusion of Contract

The following general terms and conditions are subject to all deliveries and services of ProGlass GmbH, hereinafter called ProGlass. Deviations of these terms and conditions on side of the purchaser are only recognised insofar as ProGlass expressly agrees to them in writing. The purchaser is bound to his order for three weeks. In case of unauthorised withdraw, ProGlass can claim damages including lost profit. ProGlass is entitled to decline acceptance of order for featured articles or goods out of stock, within three weeks after order has been placed.

2. Prices

All prices are net, excluding VAT (Value Added Tax). Prices are subject to change without prior notice at any time.

3. Delivery

FCA (Free Carrier) Weilheim/Teck, Germany, including packing, excluding transportation costs and customs duties. The transportation is at the consignee's risk. Apart from other delivery specifications on part of the purchaser, delivery is carried out by DHL parcel service or, depending on the size of consignment, by forwarding agent DHL.

4. Payment

Purchasing price as well as possible additional charges are payable with delivery. All invoices are to be paid to the imprest account named by ProGlass. Cheque payment is only considered as effected on day of encashment. Possible cheque fees are at the expense of the purchaser. We reserve the right to ask for payment in advance for all new customer accounts.

5. Minimum order

Please note that the different export regulations for EU, EFTA and Third countries may result in different minimum order values. To receive further information for your country please contact us.

6. Return of goods

Please use our RETURN FORM for all returns. Any returns have to be notified and authorised in advance. Acceptance of returned items is at our sole discretion. All returns are subject to a general restocking fee of 15% of the net value of goods. Items will not be credited if they are damaged, used or in any other way not saleable.

7. Warranty

Any warranty claims must be submitted immediately in written form. It is our sole right under this warranty to repair the defective item or replace it, at our option, without charge. Unless otherwise specified, all sold items are expressly warranted to be free from defects in material and workmanship for 12 months (for commercial purchasers) and 24 month respectively (for private individuals) from the date of delivery. All other warranties are disclaimed.

8. Ownership reservation

Title to the goods shall remain with the seller until all outstanding amounts are fully paid. In the case of resale the debt claim to the third party is to be assigned to the seller.

9. Data storage

Person related data in connection with the privity of contract will be stored by us.

10. Place of performance and jurisdiction

Place of performance and jurisdiction is D-73230 Kirchheim unter Teck (Germany). We reserve the right to sue at the place of the registered office or residence of the buyer.

As of July 2016 (updated version on our website www.proglass.de or upon request)